

Unit-I : Constituent Materials



- Portland Cement → Gypsum+Portland Cement Clinker (pulverizing)
- Portland Cement Clinker → Calcareous & Clayey Materials (burning)
- Paste → P.C. + Water
- Mortar → P.C. + Water + Sand
- Concrete → P.C. + Water + Sand + Gravel



RAW MATERIALS OF P.C.

1) Calcareous Rocks ($\text{CaCO}_3 > 75\%$)

- Limestone
- Marl
- Chalk
- Marine shell deposits

2) Argillocalcareous Rocks ($40\% < \text{CaCO}_3 < 75\%$)

- Cement rock
 - Clayey limestone
 - Clayey marl
 - Clayey chalk
- 

3) Argillaceous Rocks ($\text{CaCO}_3 < 40\%$)

- Clays
 - Shales
 - Slates
- Portland cement is made by mixing substances containing CaCO_3 with substances containing SiO_2 , Al_2O_3 , Fe_2O_3 and heating them to a clinker which is subsequently ground to powder and mixed with 2-6 % gypsum.

CLINKE

R



GYPSU

M



PRODUCTION STEPS

- 1) Raw materials are crushed, screemed & stockpiled.
 - 2) Raw materials are mixed with definite proportions to obtain “raw mix”. They are mixed either dry (dry mixing) or by water (wet mixing).
 - 3) Prepared raw mix is fed into the rotary kiln.
 - 4) As the materials pass through the kiln their temperature is rised upto 1300-1600 °C. The process of heating is named as “burning”. The output is known as “clinker” which is 0.15-5 cm in diameter.
- 

- 5) Clinker is cooled & stored.
- 6) Clinker is ground with gypsum (3-6%) to adjust setting time.
- 7) Packing & marketing.





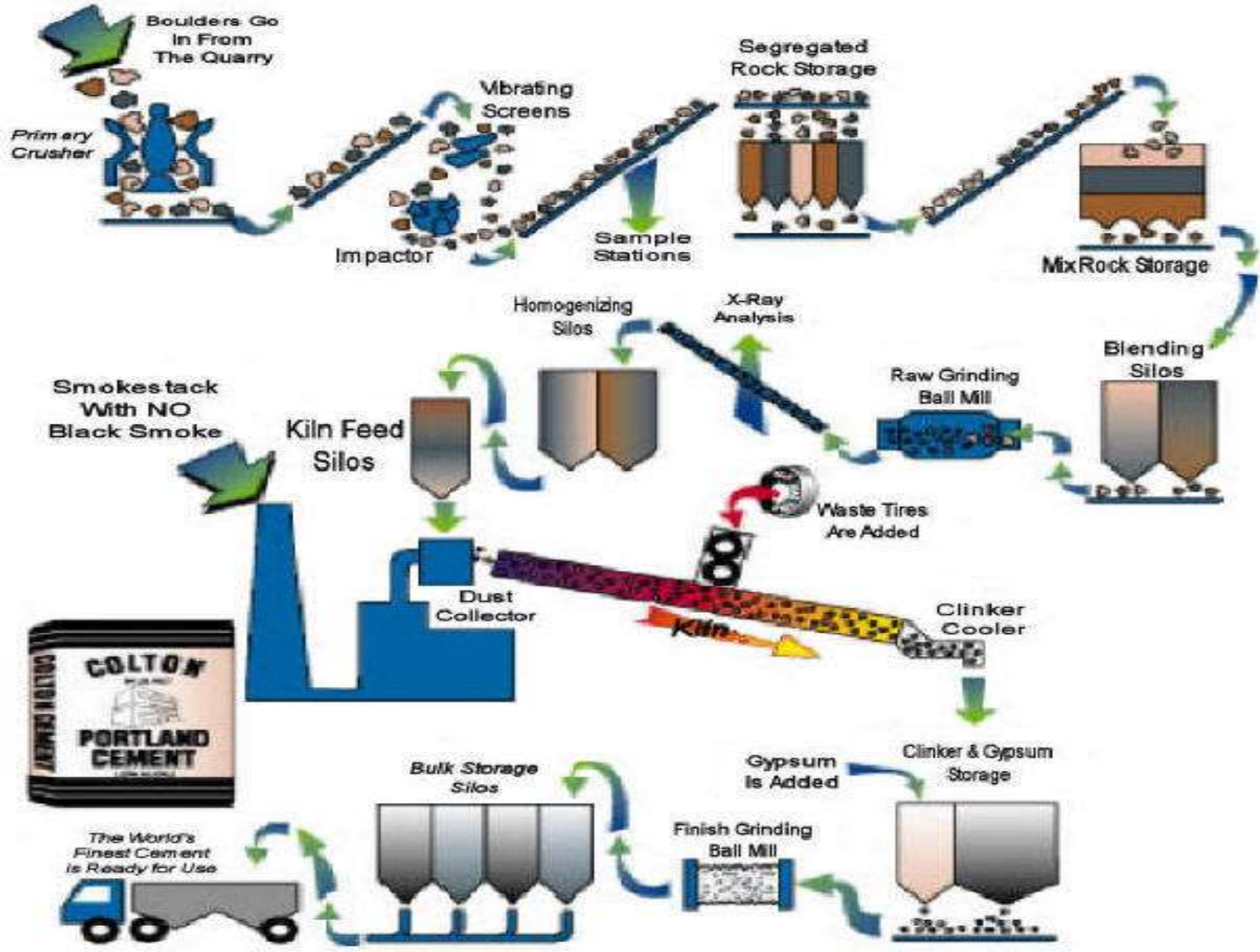

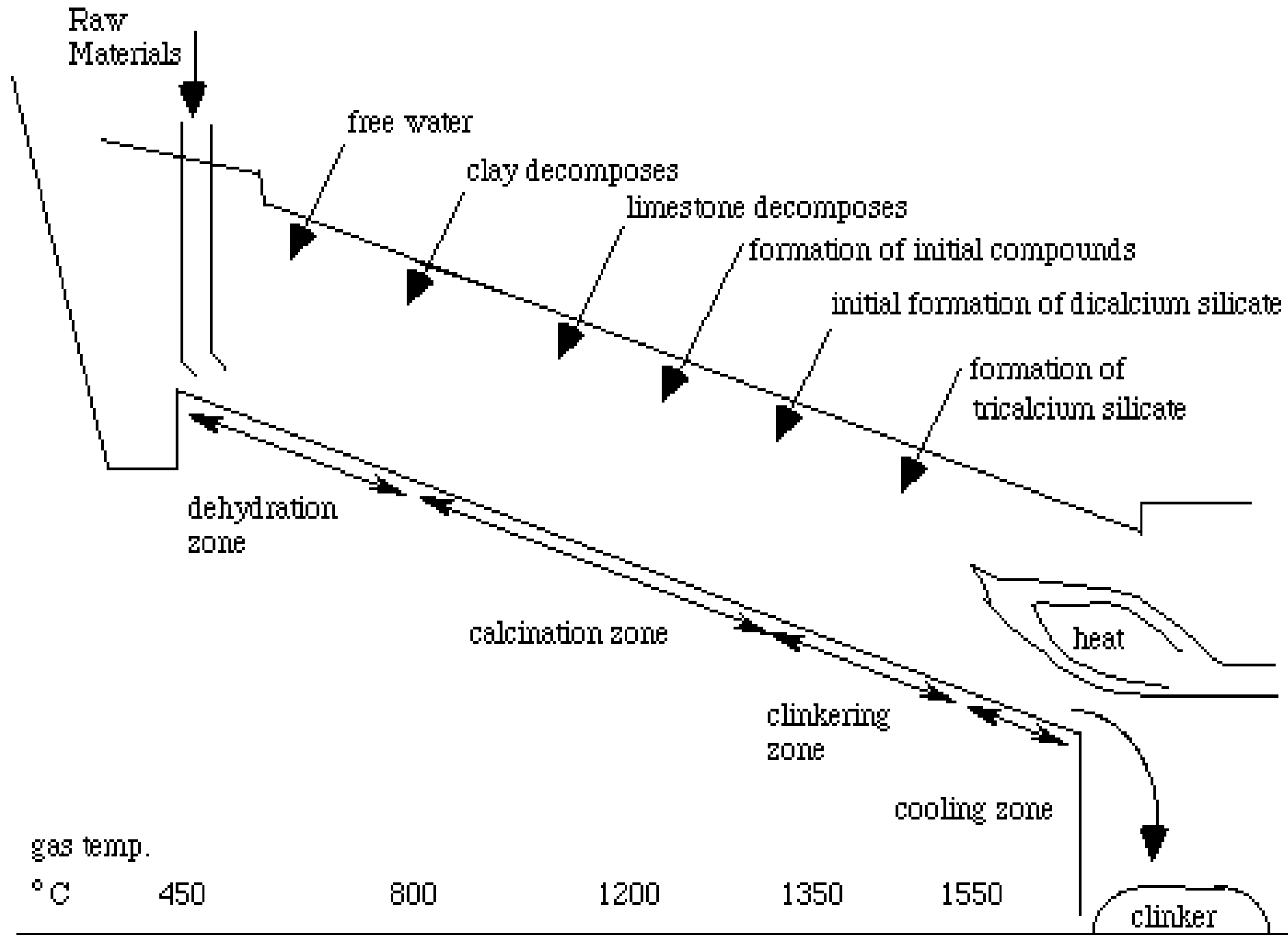

REACTIONS IN THE KILN

- $\sim 100^{\circ}\text{C}$ \rightarrow free water evaporates.
- $\sim 150\text{-}350^{\circ}\text{C}$ \rightarrow loosely bound water is lost from clay.
- $\sim 350\text{-}650^{\circ}\text{C}$ \rightarrow decomposition of clay $\rightarrow \text{SiO}_2 \& \text{Al}_2\text{O}_3$
- $\sim 600^{\circ}\text{C}$ \rightarrow decomposition of $\text{MgCO}_3 \rightarrow \text{MgO} \& \text{CO}_2$ (evaporates)
- $\sim 900^{\circ}\text{C}$ \rightarrow decomposition of $\text{CaCO}_3 \rightarrow \text{CaO} \& \text{CO}_2$ (evaporates)



- $\sim 1250-1280^{\circ}\text{C}$ \rightarrow liquid formation & start of compound formation.
- $\sim 1280^{\circ}\text{C}$ \rightarrow clinkering begins.
- $\sim 1400-1500^{\circ}\text{C}$ \rightarrow clinkering
- $\sim 100^{\circ}\text{C}$ \rightarrow clinker leaves the kiln & falls into a cooler.
- Sometimes the burning process of raw materials is performed in two stages: preheating upto 900°C & rotary kiln



CHEMICAL COMPOSITION OF P.C.

- Portland cement is composed of four major oxides (CaO , SiO_2 , Al_2O_3 , Fe_2O_3 $\geq 90\%$) & some minor oxides. Minor refers to the quantity not importance.



Oxide	Common Name	Abbreviation	Approx. Amount (%)
CaO	Lime	C	60-67
SiO ₂	Silica	S	17-25
Al ₂ O ₃	Alumina	A	3-8
Fe ₂ O ₃	Iron-oxide	F	0.5-6
MgO	Magnesia	M	0.1-4
Na ₂ O	Soda	N	0.2-1.3
K ₂ O	Potassa	K	
SO ₃	Sulfuric Anhydride	Š	1-3

Š
S

- CaO → limestone
- SiO₂-Al₂O₃ → Clay
- Fe₂O₃ → Impurity in Clays
- SO₃ → from gypsum → not from the clinker

- The amount of oxides in a P.C. Depend on the proportioning of the raw materials and how well the burning is done in the kiln. The chemical composition is found by chemical analysis.
- A typical analysis of O.P.C.

C	63.6
S	20.7
A	6
F	2.4
Ś	2.1
M	2.6
N	0.1
K	0.9
Free C	1.4
Total	99.8

- Insoluble residue=0.2
- Loss on ignition=1.4

- CaO (C), SiO_2 (S), Al_2O_3 (A) & Fe_2O_3 are the major oxides that interact in the kiln & form the major compounds.
- The proportions of these oxides determine the proportions of the compounds which affect the performance of the cement.
- SO_3 → comes largely from gypsum
- P.C. alone sets quickly so some gypsum is ground with clinker to retard the setting time.



➤ If too much gypsum is included it leads to disruptive expansions of the hardened paste or concrete.

➤ ASTM C 150 → $SO_3 \leq 3\%$ in O.P.C.

➤ $MgO + H_2O \rightarrow MH$

$C + H \rightarrow CH$ volume expansion & cause cracking.

➤ ASTM C 150 → $M < 6\%$

free C < 3%

➤ Alkalies (Na_2O & K_2O) may cause some difficulties if the cement is used with certain types of reactive aggregates in making concrete. The alkalies in the form of alkaline hydroxides can react with the reactive silica of the aggregate & resulting in volume expansion after hardening. This process may take years.

➤ Na_2O & $\text{K}_2\text{O} \leq 0.6\%$



- Insoluble Residue: is that fraction of cement which is insoluble in HCl. It comes mainly from the silica which has not reacted to form compounds during the burning process in the kiln. All compounds of P.C. is soluble in HCl except the silica.
- The amount of I.R., determined by chemical analysis, serves to indicate the completeness of the reactions in the kiln.
- ASTM C 150 → I.R. $\leq 0.75\%$



- Loss on Ignition (L.O.I.): is the loss in weight of cement after being heated to 1000°C. It indicates the prehydration or carbonation due to prolonged or improper storage of cement & clinker.
- If cement is exposed to air, water & CO₂ are absorbed & by heating the cement upto 1000°C loose these two substances.
- ASTM C 150 → L.O.I. ≤ 3% for O.P.C.



COMPOUND COMPOSITION OF P.C. (OR CLINKER)

- Oxides interact with each other in the kiln to form more complex products (compounds). Basically, the major compounds of P.C. can be listed as:

Name	Chemical Formula	Abbreviations
Tri Calcium Silicate	$3\text{CaO} \cdot \text{SiO}_2$	C_3S
Di Calcium Silicate	$2\text{CaO} \cdot \text{SiO}_2$	C_2S
Tri Calcium Aluminate	$3\text{CaO} \cdot \text{Al}_2\text{O}_3$	C_3A
Tetra Calcium Alumino Ferrite	$4\text{CaO} \cdot \text{Al}_2\text{O}_3 \cdot \text{Fe}_2\text{O}_3$	C_4AF

- The degree to which the potential reactions can proceed to “equilibrium” depends on:
- 1) Fineness of raw materials & their intermixing.
 - 2) The temperature & time that mix is held in the critical zone of the kiln.
 - 3) The grade of cooling of clinker may also be effective on the internal structure of major compounds.
- 

- There are also some minor compounds which constitute few %, so they are usually negligible. Moreover, portland cement compounds are rarely pure.
- For example in C_3S , MgO & Al_2O_3 replaces CaO randomly.
- $C_3S \rightarrow ALITE$ & $C_2S \rightarrow BELITE$
- Ferrite Phase: C_4AF is not a true compound. The ferrite phase ranges from C_2AF to C_6AF . * C_4AF represents an average.



Methods of Determining Compound Composition

- Each grain of cement consists of an intimate mixture of these compounds.
- They can be determined by:

- 1) Microscopy
- 2) X-Ray Diffraction

- But due to the variabilities involved the compound composition is usually calculated using the oxide proportions.

- 3) Calculations (Bouge's Equations)

Assumptions

- 1) The chemical reactions in the kiln proceeded to equilibrium.
- 2) Compounds are in pure form such as C_3S & C_2S
- 3) Presence of minor compounds are ignored.
- 4) Ferrite phase can be calculated as C_4AF
- 5) All oxides in the kiln have taken part in forming the compounds.



➤ $\%C_3S = 4.071(\%C) - 7.6(\%S) - 6.718(\%A) - 1.43(\%F) - \underline{2.852(\%S)}$

➤ $\%C_2S = 2.867(\%S) - 0.7544(\%C_3S)$

➤ $\%C_3A = 2.650(\%A) - 1.692(\%F)$

➤ $\%C_4AF = 3.043(\%F)$



Ex: Given the following oxide composition of a portland cement clinker.

$$\text{CaO}=64.9\% \quad \text{SiO}_2=22.2\%$$

$$\text{Al}_2\text{O}_3=5.8\% \quad \text{Fe}_2\text{O}_3=3.1\% \quad \text{MgO}=4\%$$

Using Bogue's eqn's calculate the compound composition of the P.C. clinker?

$$\text{C}_3\text{S}=4.071*64.9-7.6*22.2-6.718*5.8-1.43*3.1=52.1\%$$

$$\text{C}_2\text{S}=2.876*22.2-0.7544*52.1=24.5\%$$

$$\text{C}_3\text{A}=2.65*5.8-1.692*3.1=10.1\%$$

$$C_4AF = 3.043 * 3.1 = 9.4\%$$

- To see the effect of change in oxide composition on the change in compound composition, assume that CaO is 63.9% & SiO₂ is 23.2% and others are the same.

$$C_3S = 40.4\% , C_2S = 36.2\% , C_3A = 10\% , C_4AF = 9.4\%$$

C₃S changed from 52.1% → 40.4%

C₂S changed from 24.5% → 36.2%

- 1% change in CaO & SiO₂ resulted in more than 10% change in C₃S & C₂S content.



Influence of Compound Composition on Characteristics of P.C.

- P.C.+water→the compounds in the cement undergo chemical reactions with the water independently, and different products result from these reactions.

	C_3S	C_2S	C_3A	C_4AF
Rate of Reaction	Moderate	Slow	Fast	Moderate
Heat Liberation	High	Low	Very High	Moderate
Early Cementitious Value	Good	Poor	Good	Poor
Ultimate Cementitious Value	Good	Good	Poor	Poor

ASTM Type & Name of P.C.	Average Compound Composition				
	C ₃ S	C ₂ S	C ₃ A	C ₄ AF	
Type I - O.P.C.	49	25	12	8	General Purpose
Type II - Modified	46	29	6	12	For Moderate Heat of Hydration
Type III - High Early Strength	56	15	12	8	C ₃ S&C ₃ A increased, C ₂ S decreased
Type IV - Low Heat P.C.	30	46	5	13	C ₂ S increased
Type V - Sulfate Resistant P.C.	43	36	4	12	Limit on C ₃ A≤5%, 2C ₃ A+C ₄ AF≤25%



Hydration of P.C.

- Hydration: Chemical reactions with water.
- As water comes into contact with cement particles, hydration reactions immediately starts at the surface of the particles. Although simple hydrates such as C-H are formed, process of hydration is a complex one and results in reorganization of the constituents of original compounds to form new hydrated compounds.

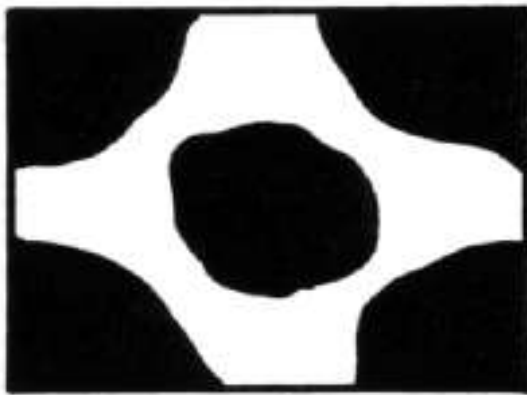

A

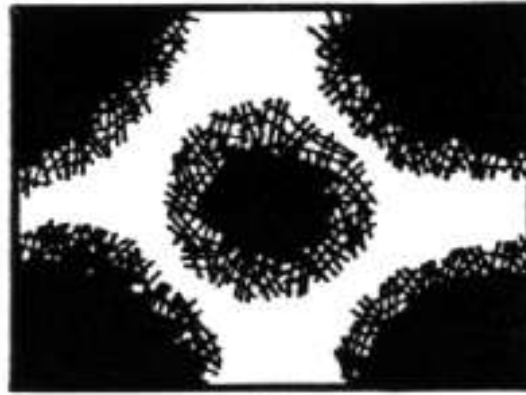

B

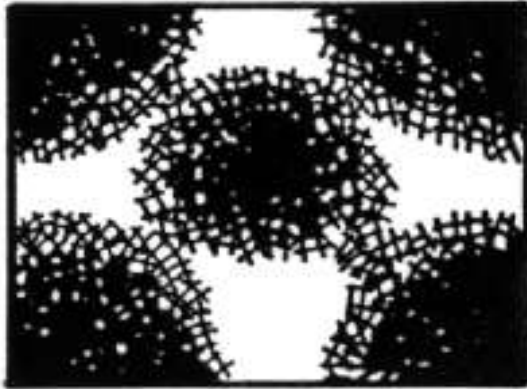

C

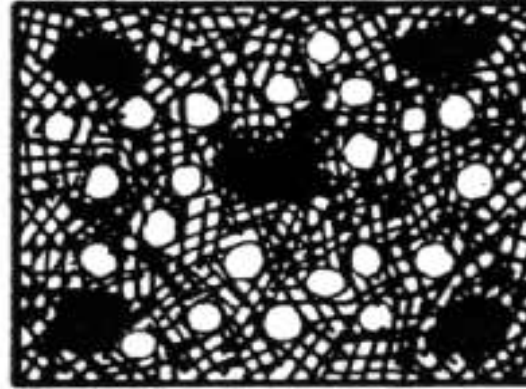

D



unhydrated
cement particles

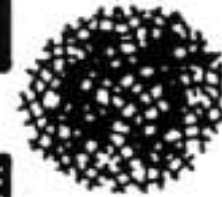

cement gel

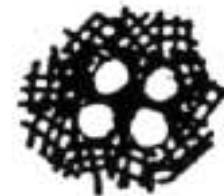

capillary pores
and cavities

A) Immediately after mixing

B) Reaction around particles - early stiffening

C) Formation of skeletal structure - first hardening

D) Gel infilling - later hardening

- At any stage of hydration the hardened cement paste (hcp) consists of:
- Hydrates of various compounds referred to collectively as GEL.
 - Crystals of calcium hydroxide (CH).
 - Some minor compound hydrates.
 - Unhydrated cement
 - The residual of water filled spaces – pores.



➤ As the hydration proceeds the deposits of hydrated products on the original cement grains makes the diffusion of water to unhydrated nucleus more & more difficult. Thus, the rate of hydration decreases with time & as a result hydration may take several years.

➤ Major compounds start to produce:

- Calcium-silicate-hydrate gels
 - Calcium hydroxide
 - Calcium-alumino-sulfohydrates
- _____cement
_____gel

- At the beginning of mixing, the paste has a structure which consists of cement particles with water-filled space between them. As hydration proceeds, the gels are formed & they occupy some of this space.
- 1cc of cement → 2.1cc of gel
- Gel Pores: 28% of the total gel volume have diameter of 0.015-0.020 μm . (very small-loss or gain of water is difficult)

- Capillary Pores: 12.5 μm diameter, with varying sizes, shapes & randomly distributed in the paste.
- Volume of capillary pores decreases as hydration takes place. Water in capillary pores is mobile, can not be lost by evaporation or water can get into the pores. They are mainly responsible for permeability.

➤ - w/c ratio

===== capillary porosity

- degree of hydration



- C₂S & C₃S: 70-80% of cement is composed of these two compounds & most of the strength giving properties of cement is controlled by these compounds.
- Upon hydration both calcium-silicates result in the same products.
$$2C_3S + 6H \rightarrow C_3S_2H_3 + 3CH$$
$$2C_2S + 4H \rightarrow C_3S_2H_3 + CH$$
- Calcium-Silicate-Hydrate (C-S-H gel) is similar to a mineral called "TOBERMORITE". As a result it is named as "TOBERMORITE GEL"



- Upon hydration C_3S & C_2S , CH also forms which becomes an integral part of hydration products. CH does not contribute very much to the strength of portland cement.
- C_3S having a faster rate of reaction accompanied by greater heat generation develops early strength of the paste. On the other hand, C_2S hydrates & hardens slowly so results in less heat generation & develops most of the ultimate strength.

➤ Higher C_3S → higher early strength-higher heat generation (roads, cold environments)

Higher C_2S → lower early strength-lower heat generation (dams)

➤ C_3A : is characteristically fast reacting with water & may lead to a rapid stiffening of the paste with a large amount of the heat generation (Flash-Set)-(Quick-Set). In order to prevent this rapid reaction gypsum is added to the clinker. Gypsum, C_3A & water react to form relatively insoluble Calcium-Sulfo-Aluminates.

$C_3A + C\acute{S}H_2 + 10H \rightarrow C_4A\acute{S}H_{12}$ (calcium- aluminomonosulfohydrate)

$C_3A + 3C\acute{S}H_2 + 26H \rightarrow C_6A\acute{S}_3H_{32}$ (calcium-aluminotrisulfohydrate “ettringite”)

- When there is enough gypsum “ettringite” forms with great expansion
- If there is no gypsum → flash-set
more gypsum → ettringite
formation increases
which will cause cracking



- Also Calcium-Sulfo Aluminates are prone (less resistant) to sulfate attack & does not contribute much for strength. The cement to be used in making concretes that are going to be exposed to soils or waters that contain sulfates should not contain more than 5% C_3A .
- C_4AF : The hydration of ferrite phase is not well understood. Ferrite phase has lesser role in development of strength. The hydration products are similar to C_3A . Alumina & iron oxide occur interchangeably in the hydration products.



HEAT OF HYDRATION

- Hydration process of cement is accompanied by heat generation (exothermic).
- As concrete is a fair insulator, the generated heat in mass concrete may result in expansion & cracking. This could be overcome by using suitable cement type.
- It could also be advantages for cold weather concreting.
- The heat of hydration of OPC is on the order of 85-100 cal/gr.
- About 50% of this heat is liberated within 1-3 days & 75% within 7 days.
- By limiting C_3S & C_3A content heat of hydration can be reduced.

CEMENT 116 W/C=0.40 T=25 C

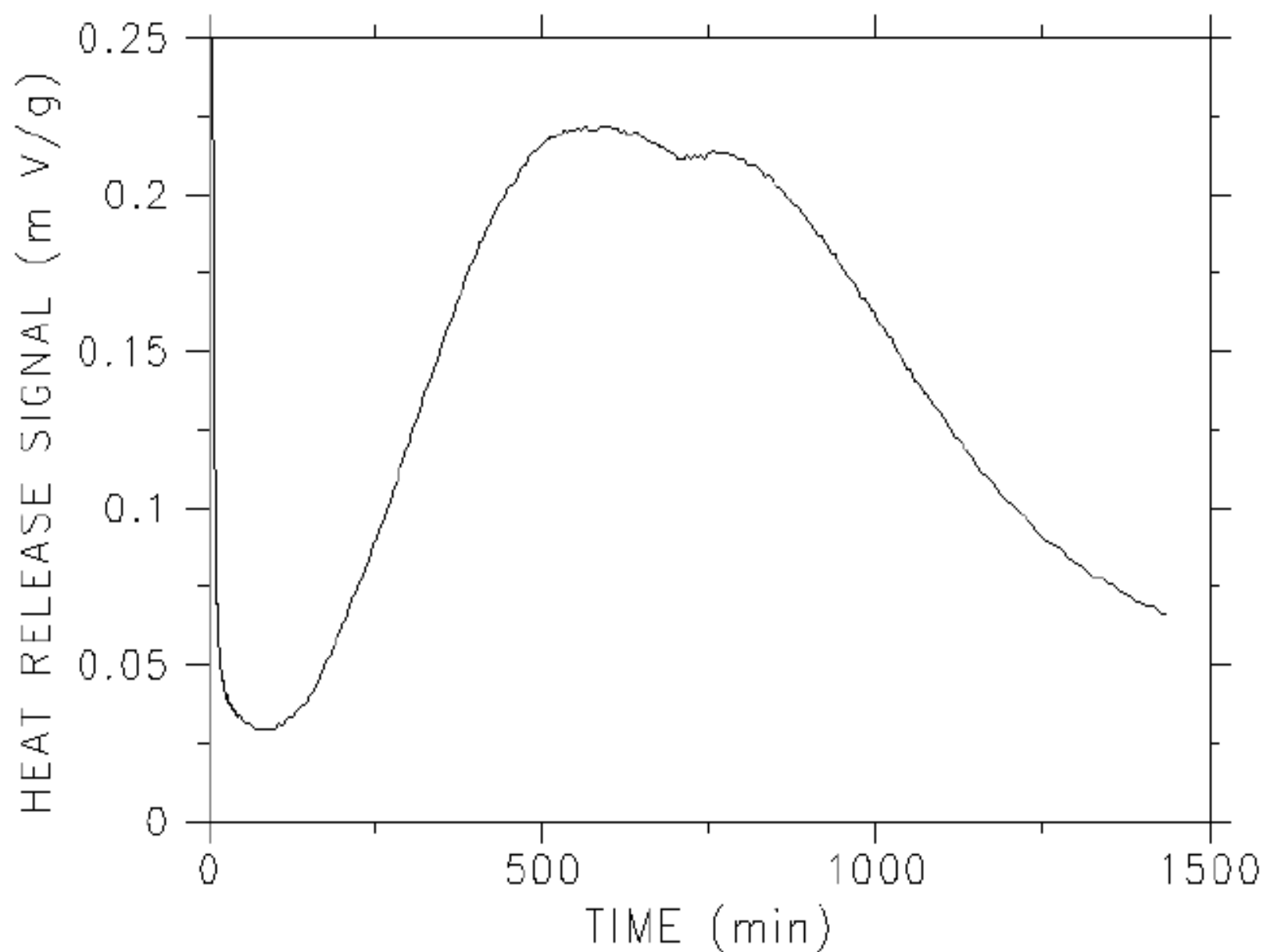

Heat of Hydration of Pure Compounds

	Heat of Hydration (cal/gr)
C_3S	120
C_2S	62
C_3A	207
C_4AF	100

- The amount of heat liberated is affected by the fractions of the compounds of the cement.
- Heat of Hydration(cal/gr)= $120*(\%C_3S)+62*(\%C_2S)+207*(\%C_3A)+100*(\%C_4AF)$

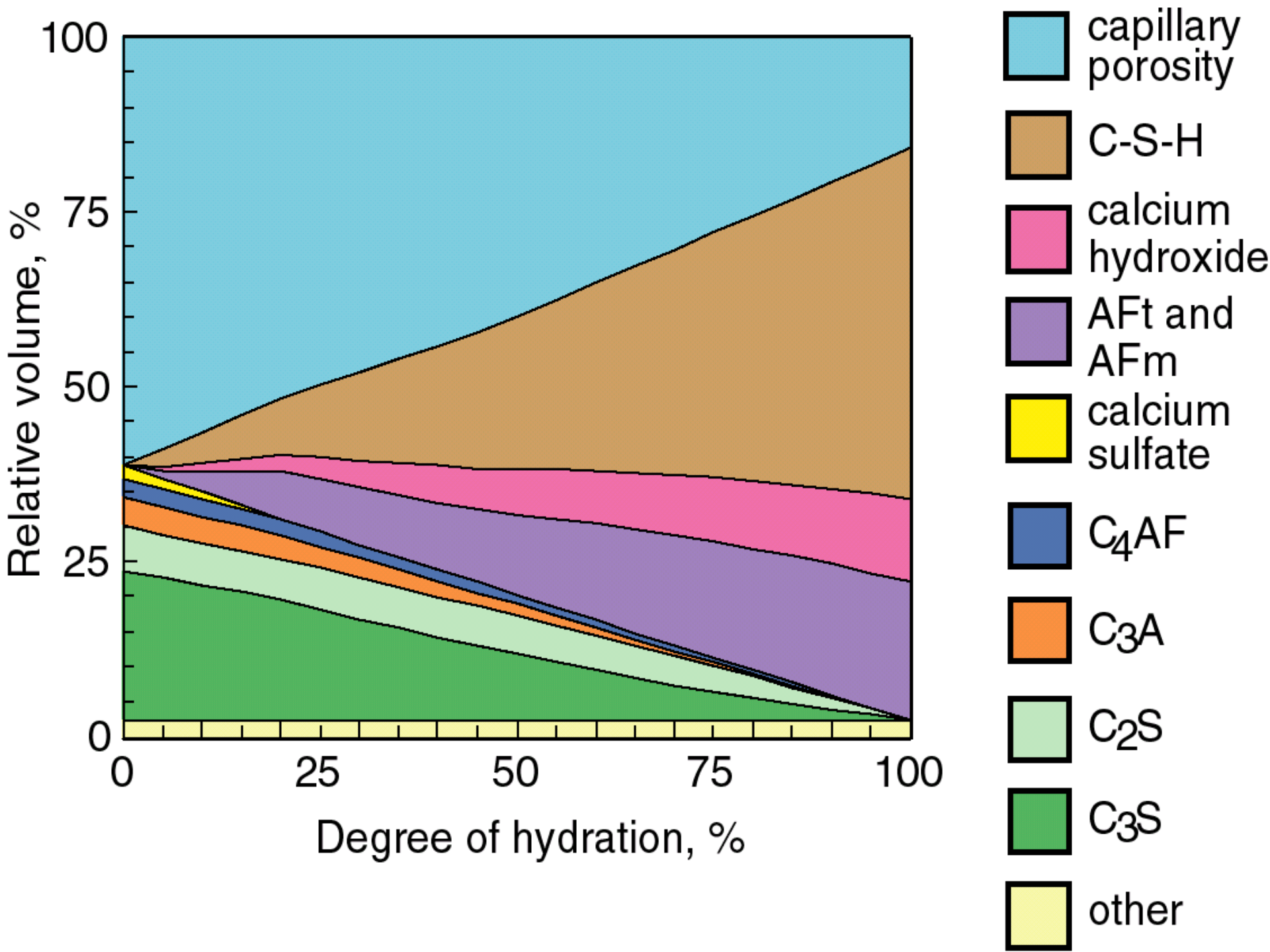

FINENESS OF CEMENT

- As hydration takes place at the surface of the cement particles, it is the surface area of cement particles which provide the material available for hydration. The rate of hydration is controlled by fineness of cement. For a rapid rate of hydration a higher fineness is necessary.



➤ However,

- Higher fineness requires higher grinding (cost ↑)
- Finer cements deteriorate faster upon exposure to atmosphere.
- Finer cements are very sensitive to alkali-aggregate reaction.
- Finer cements require more gypsum for proper hydration.
- Finer cements require more water.

- Fineness of cement is determined by air permeability methods. For example, in the Blaine air permeability method a known volume of air is passed through cement. The time is recorded and the specific surface is calculated by a formula.
- Fineness is expressed in terms of specific surface of the cement (cm^2/gr). For OPC specific surface is 2600-3000 cm^2/gr .



Sieving



Blaine Apparatus

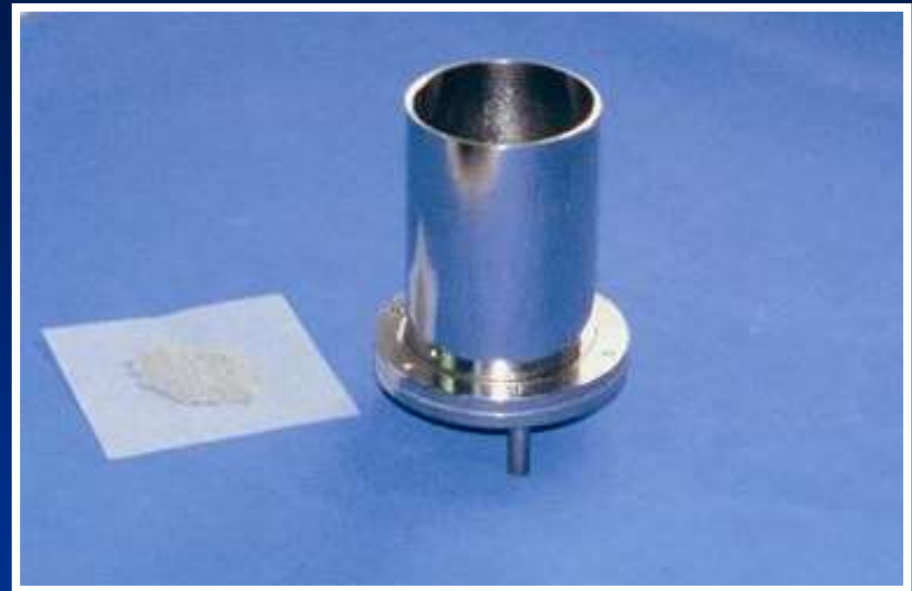

SETTING

- Setting refers to a change from liquid state to solid state. Although, during setting cement paste acquires some strength, setting is different from hardening.
- The water content has a marked effect on the time of setting. In acceptance tests for cement, the water content is regulated by bringing the paste to a standard condition of wetness. This is called “normal consistency”.



- Normal consistency of O.P.C. Ranges from 20-30% by weight of cement.
- Vicat apparatus is used to determine normal consistency. Normal consistency is that condition for which the penetration of a standard weighed plunger into the paste is 10mm in 30sec. By trial & error determine the w/c ratio.
- In practice, the terms initial set & final set are used to describe arbitrary chosen time of setting. Initial set indicates the beginning of a noticeable stiffening & final set may be regarded as the start of hardening (or complete loss of plasticity).

Gillmore Needle

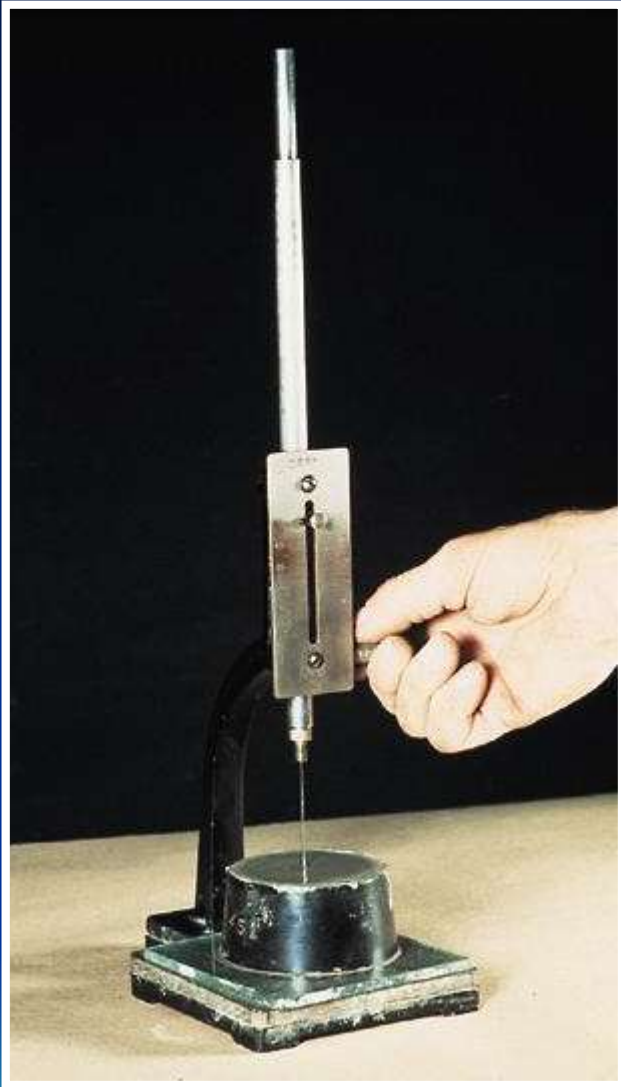

Vicat Needle

➤ Setting can be obtained by using the vicat apparatus.

➤ ASTM C150

- Initial setting time > 45min
- Final setting time < 375min

➤ TS 19

- Initial > 1hr (60min)
- Final < 8hr (480min)

Factors Affecting Setting Time

- Temperature & Humidity
- Amount of Water
- Chemical Composition of Cement
- Fineness of Cement (finer cement, faster setting)



Flash-Set: is the immediate stiffening of cement paste in a few minutes after mixing with water. It is accompanied by large amount of heat generation upon reaction of C3A with water.

- Gypsum is placed in cement to prevent flash-set. The rigidity can not be overcome & plasticity may not be regained without addition of water.
- Amount of gypsum must be such that it will be used upto almost hardening. Because expansion caused by ettringite can be distributed to the paste before hardening. More gypsum will cause undesirable expansion after hardening.

False-Set: is a rapid development of rigidity of cement paste without generation of much heat. This rigidity can be overcome & plasticity can be regained by further mixing without addition of water. In this way cement paste restores its plasticity & sets in a normal manner without any loss of strength.

➤ Probable Causes of False-Set:

- 1) When gypsum is ground by too hot of a clinker, gypsum may be dehydrated into hemihydrate ($\text{CaSO}_4 \cdot 1/2\text{H}_2\text{O}$) or anhydrate (CaSO_4). These materials when react with water gypsum is formed, which results in stiffening of the paste.

2) Alkali oxides in cement may carbonate during storage. Upon mixing such a cement with water, these alkali carbonates will react with Ca(OH)_2 (CH-Calcium Hydroxide) liberated by hydrolysis of C_3S resulting in CaCO_3 . CaCO_3 precipitates in the mix & results in false-set.



SOUNDNESS OF CEMENT

- Soundness is defined as the volume stability of cement paste.
 - The cement paste should not undergo large changes in volume after it has set. Free CaO&MgO may result in unsound cement. Upon hydration C&M will form CH&MH with volume increase thus cracking.
 - Since unsoundness is not apparent until several months or years, it is necessary to provide an accelerated method for its determination.
- 1) Lechatelier Method: Only free CaO can be determined.
 - 2) Autoclave Method: Both free CaO&MgO can be determined.

STRENGTH OF CEMENT

- Strength tests are not carried out on neat cement pastes, because it is very difficult to form these pastes due to cohesive property of cement.
- Strength tests are carried out on cement mortar prepared by standard gradation (1 part cement+3 parts sand+1/2 part water)



1) Direct Tension (Tensile Strength):

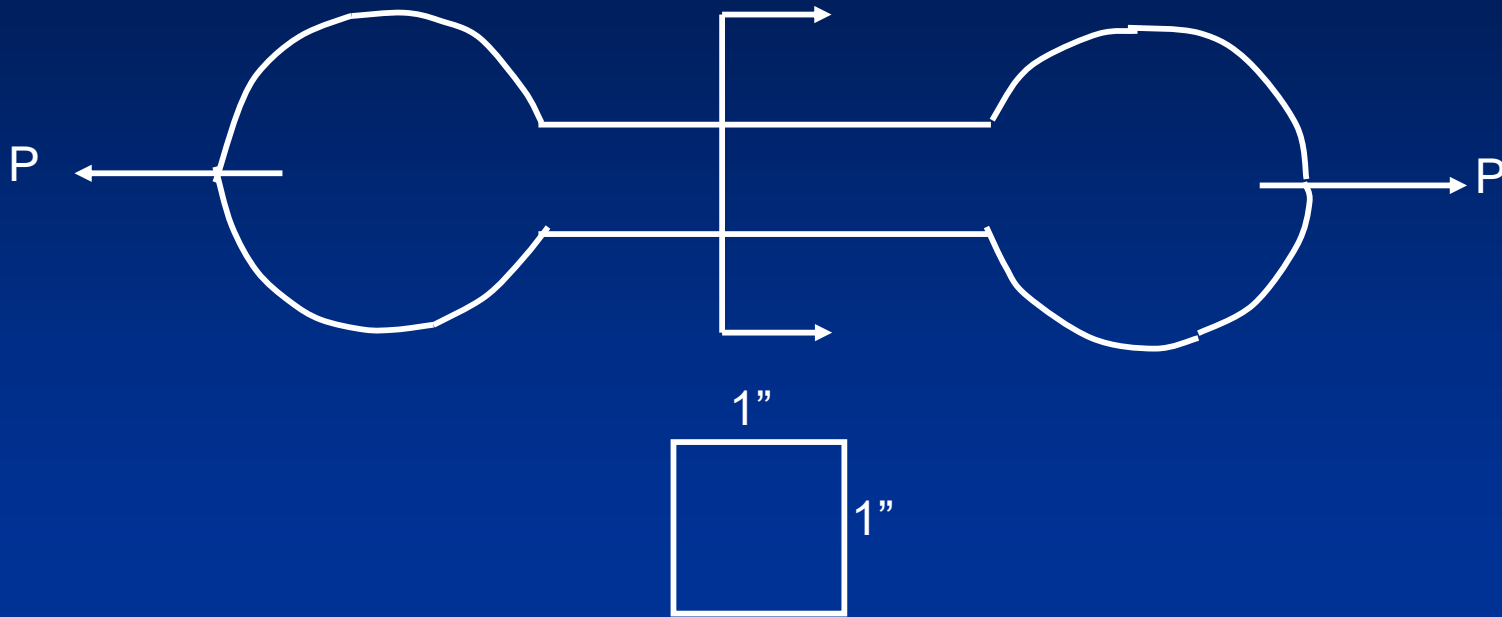

- $\sigma_t = P/1\text{in}^2$
- Difficult test procedure

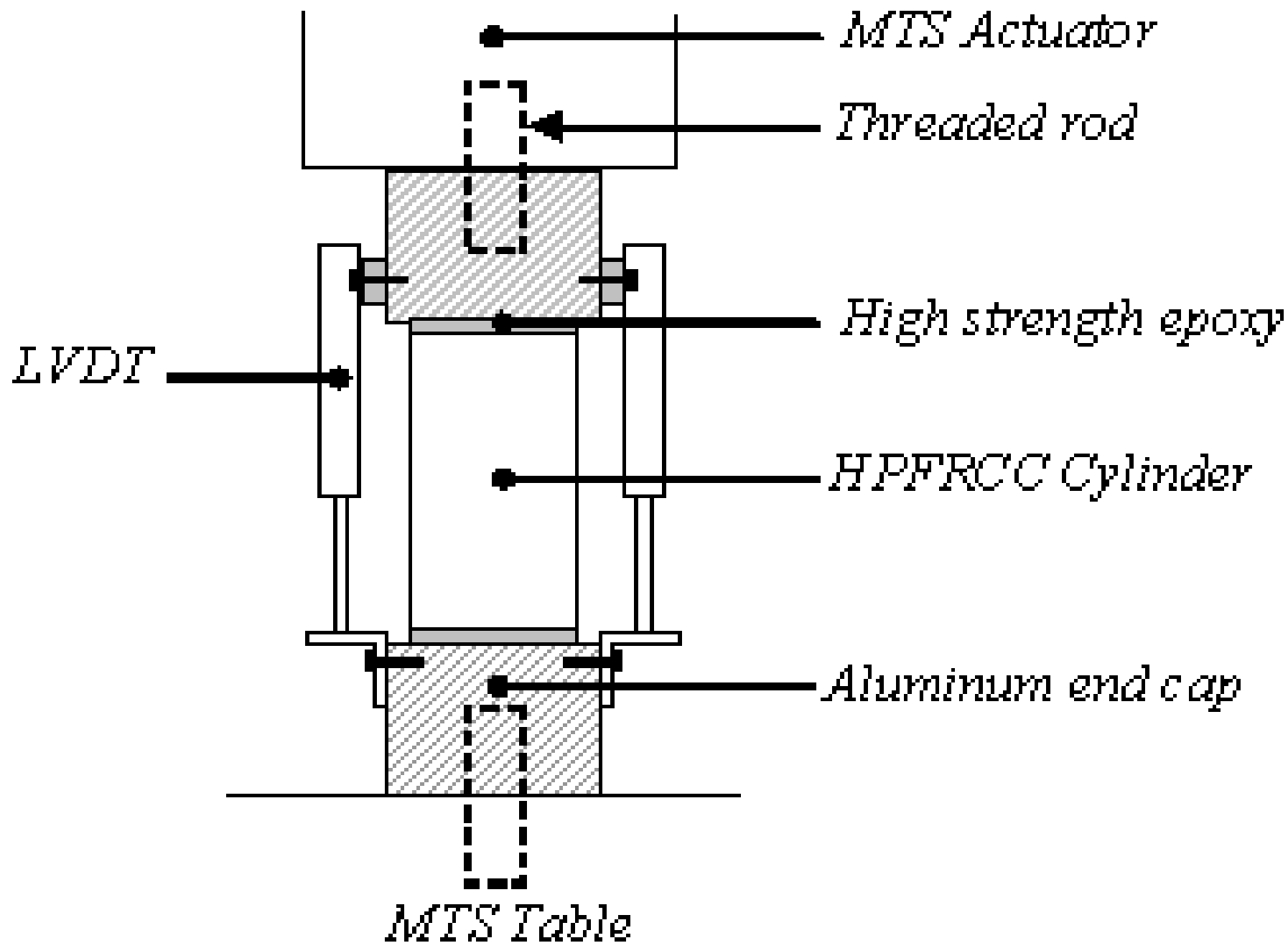

2) Flexural Strength (tensile strength in bending):

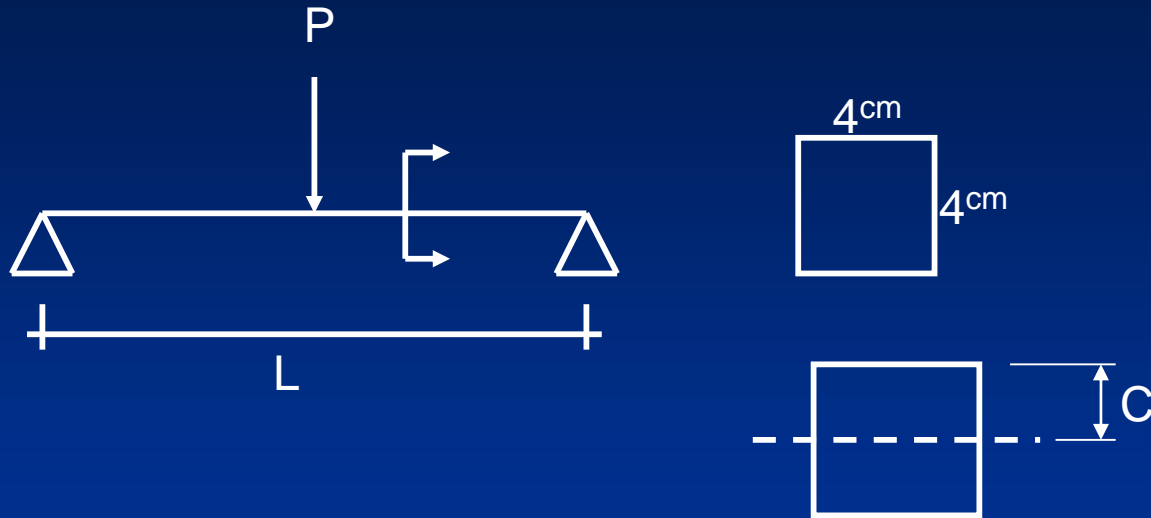

- $\sigma_f = (M \cdot C) / I$
- M : maximum moment
- I : moment of inertia
- C : distance to bottom fiber from C.G.

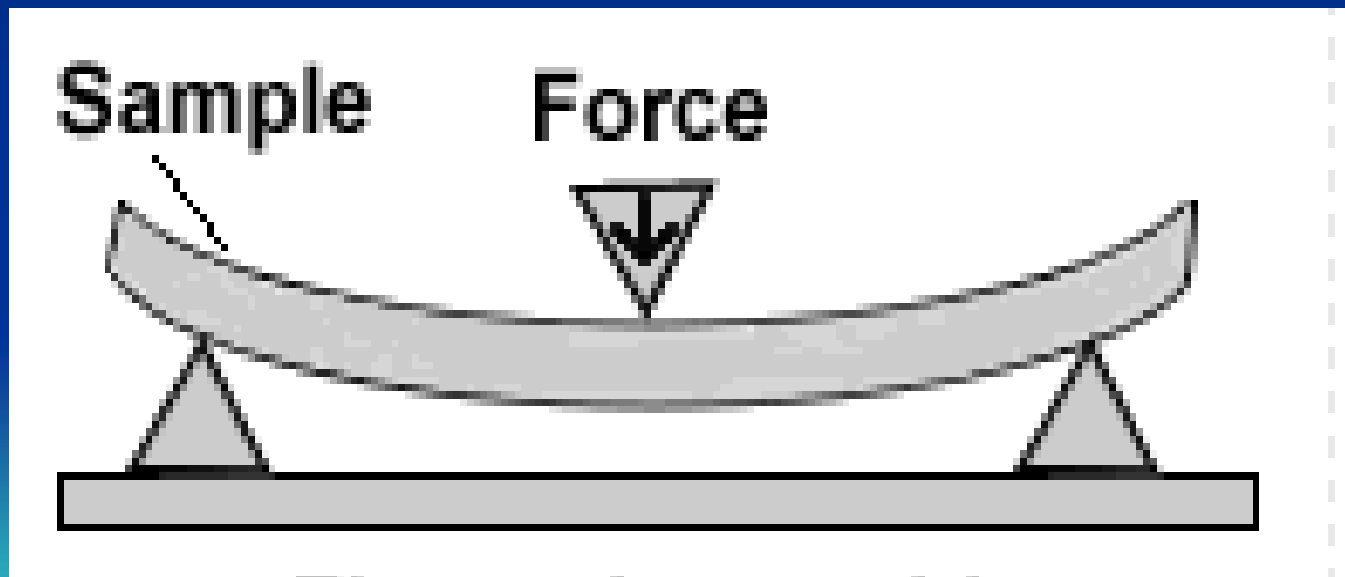
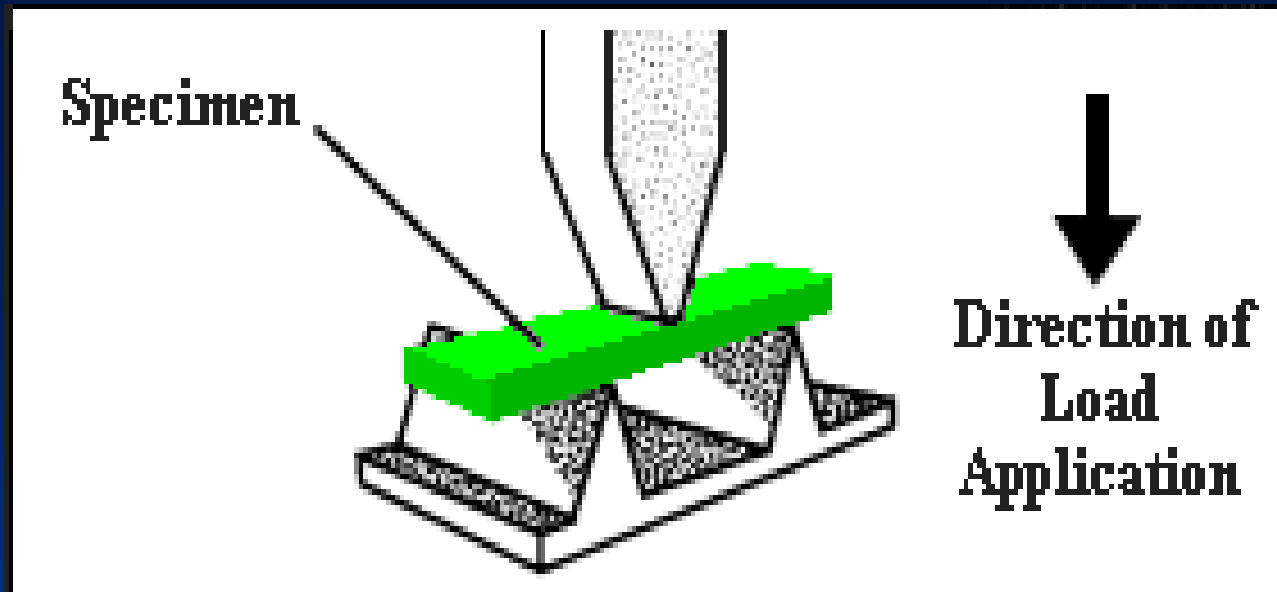

3) Compression Test:

i) Cubic Sample

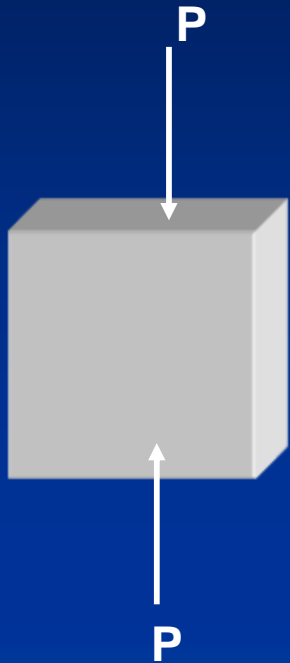

$$\sigma_c = P/A$$

ii) Flexural Sample after it is broken

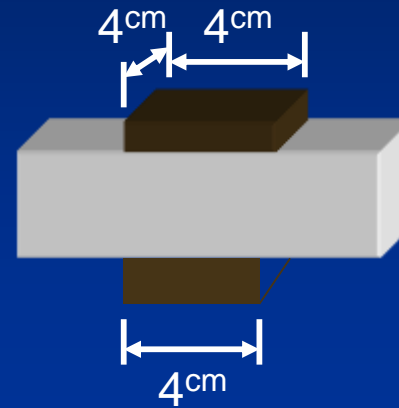

$$\sigma_c = P/A$$

$$A = 4 \times 4$$



TYPES OF PORTLAND CEMENT

- Cements of different chemical composition & physical characteristics may exhibit different properties when hydrated. It should thus be possible to select mixtures of raw materials for the production of cements with various properties.
- In fact several cement types are available and most of them have been developed to ensure durability and strength properties to concrete.

➤ It should also be mentioned that obtaining some special properties of cement may lead to undesirable properties in another respect. For this reason a balance of requirements may be necessary and economic aspects should be considered.

1) Standard Types: these cements comply with the definition of P.C., and are produced by adjusting the proportions of four major compounds.

2) Special Types: these do not necessarily comply with the definition of P.C. & are produced by using additional raw materials.

Standard Cements (ASTM)

- Type I: Ordinary Portland Cement
Suitable to be used in general concrete construction when special properties are not required.
- Type II: Modified Portland Cement
Suitable to be used in general concrete construction. Main difference between Type I&II is the moderate sulfate resistance of Type II cement due to relatively low C₃A content ($\leq 8\%$). Since C₃A is limited rate of reactions is slower and as a result heat of hydration at early ages is less. *It is suitable to be used in small scale mass concrete like retaining walls.

➤ Type III: High Early Strength P.C.

Strength development is rapid.

3 days $f'_c = 7$ days f'_c of Type I

It is useful for repair works, cold weather & for early demolding.

Its early strength is due to higher C_3S & C_3A content.

➤ Type IV: Low Heat P.C.

Generates less heat during hydration & therefore gain of strength is slower.

In standards a maximum value of C_3S & C_3A & a minimum value for C_2S are placed.

It is used in mass-concrete and hot-weather concreting.

➤ Type V: Sulfate Resistant P.C.

Used in construction where concrete will be subjected to external sulfate attack – chemical plants, marine & harbor structures.

- i) During hydration C_3A reacts with gypsum & water to form ettringite. In hardened cement paste calcium-alumino-hydrate can react with calcium&alumino sulfates, from external sources, to form ettringite which causes expansion & cracking.
- ii) C-H and sulfates can react & form gypsum which again causes expansion & cracking.

* In Type V C_3A is limited to 5%.

➤ Type IA, IIA, IIIA: Air Entrained Portland Cement

Only difference is adding an air-entraining agent to the cement during manufacturing to increase freeze-thaw resistance by providing small sized air bubbles in concrete.



SPECIAL CEMENTS

- Portland Pozzolan Cement (P.P.C.)
 - By grinding & blending P.C. Clinker+Pozzolan+Gypsum
 - P.P.C. Produces less heat of hydration & offers higher sulfate resistance so it can be used in marine structures & mass concrete.
 - However, most pozzolans do not contribute to strength at early ages.
 - The early strength of PPC is less.

- Portland Blast Furnace Slag Cement (P.B.F.S.C.)
 - By intergrinding B.F.S.+P.C. Clinker+Gypsum
 - This cement is less reactive (rate of gain of strength & early strength is less but ultimate strength is same)
 - High sulfate resistance
 - Suitable to use in mass concrete construction
 - Unsuitable for cold weather concreting

- Both P.P.C.&P.B.F.S.C. Are called blended cements. Their heat of hydration & strength development are low in early days. Because upon adding water C_3S compounds start to produce C-S-H gels & CH. The CH & the pozzolanic material react together to produce new C-S-H gels. That's why the early strength is low but the ultimate strength is the same when compared to O.P.C.

➤ White Portland Cement

- W.P.C. Is made from materials containing a little iron oxide & manganese oxide.
- $\text{Fe}_2\text{O}_3 + \text{MnO} \leq 0.8\%$
- To avoid contamination by coal ash, oil is used as fuel.
- To avoid contamination by iron during grinding, instead of steel balls nickel-molybdenum alloys are used.



Unit-II : Admixtures and Their Effects



Admixtures



Fig. 6-1. Liquid admixtures, from left to right: antiwashout admixture, shrinkage reducer, water reducer, foaming agent, corrosion inhibitor, and air-entraining admixture. (69795)

Admixtures are those ingredients in concrete other than Portland cement, water, and aggregates that are added to the mixture immediately before or during mixing ([Fig. 6-1](#)). Admixtures can be classified by function as follows:



1. Air-entraining admixtures
2. Water-reducing admixtures
3. Plasticizers
4. Accelerating admixtures
5. Retarding admixtures
6. Hydration-control admixtures



7. Corrosion inhibitors
8. Shrinkage reducers
9. Alkali-silica reactivity inhibitors
10. Colouring admixtures
11. Miscellaneous admixtures such workability, bonding, damp proofing, permeability reducing, grouting, gas-forming, and pumping admixtures



Table 6-1. Concrete Admixtures by Classification

Type of admixture	Desired effect	Material
Accelerators (ASTM C 494 and AASHTO M 194, Type C)	Accelerate setting and early-strength development	Calcium chloride (ASTM D 98 and AASHTO M 144) Triethanolamine, sodium thiocyanate, calcium formate, calcium nitrite, calcium nitrate
Air detrainers	Decrease air content	Tributyl phosphate, dibutyl phthalate, octyl alcohol, water-insoluble esters of carbonic and boric acid, silicones
Air-entraining admixtures (ASTM C 260 and AASHTO M 154)	Improve durability in freeze-thaw, deicers, sulfate, and alkali-reactive environments Improve workability	Salts of wood resins (Vinsol resin), some synthetic detergents, salts of sulfonated lignin, salts of petroleum acids, salts of proteinaceous material, fatty and resinous acids and their salts, alkylbenzene sulfonates, salts of sulfonated hydrocarbons
Alkali-aggregate reactivity inhibitors	Reduce alkali-aggregate reactivity expansion	Barium salts, lithium nitrate, lithium carbonate, lithium hydroxide
Antiwashout admixtures	Cohesive concrete for underwater placements	Cellulose, acrylic polymer
Bonding admixtures	Increase bond strength	Polyvinyl chloride, polyvinyl acetate, acrylics, butadiene-styrene copolymers
Coloring admixtures (ASTM C 979)	Colored concrete	Modified carbon black, iron oxide, phthalocyanine, umber, chromium oxide, titanium oxide, cobalt blue
Corrosion inhibitors	Reduce steel corrosion activity in a chloride-laden environment	Calcium nitrite, sodium nitrite, sodium benzoate, certain phosphates or fluosilicates, fluoaluminates, ester amines
Dampproofing admixtures	Retard moisture penetration into dry concrete	Soaps of calcium or ammonium stearate or oleate Butyl stearate Petroleum products
Foaming agents	Produce lightweight, foamed concrete with low density	Cationic and anionic surfactants Hydrolyzed protein
Fungicides, germicides, and insecticides	Inhibit or control bacterial and fungal growth	Polyhalogenated phenols Dieldrin emulsions Copper compounds
Gas formers	Cause expansion before setting	Aluminum powder
Grouting admixtures	Adjust grout properties for specific applications	See Air-entraining admixtures, Accelerators, Retarders, and Water reducers
Hydration control admixtures	Suspend and reactivate cement hydration with stabilizer and activator	Carboxylic acids Phosphorus-containing organic acid salts
Permeability reducers	Decrease permeability	Latex Calcium stearate
Pumping aids	Improve pumpability	Organic and synthetic polymers Organic flocculents Organic emulsions of paraffin, coal tar, asphalt, acrylics Bentonite and pyrogenic silicas Hydrated lime (ASTM C 141)
Retarders (ASTM C 494 and AASHTO M 194, Type B)	Retard setting time	Lignin Borax Sugars Tartaric acid and salts
Shrinkage reducers	Reduce drying shrinkage	Polyoxyalkylene alkyl ether Propylene glycol
Superplasticizers* (ASTM C 1017, Type 1)	Increase flowability of concrete Reduce water-cement ratio	Sulfonated melamine formaldehyde condensates Sulfonated naphthalene formaldehyde condensates Lignosulfonates Polycarboxylates

Table 6-1. Concrete Admixtures by Classification (Continued)

Type of admixture	Desired effect	Material
Superplasticizer* and retarder (ASTM C 1017, Type 2)	Increase flowability with retarded set Reduce water-cement ratio	See superplasticizers and also water reducers
Water reducer (ASTM C 494 and AASHTO M 194, Type A)	Reduce water content at least 5%	Lignosulfonates Hydroxylated carboxylic acids Carbohydrates (Also tend to retard set so accelerator is often added)
Water reducer and accelerator (ASTM C 494 and AASHTO M 194, Type E)	Reduce water content (minimum 5%) and accelerate set	See water reducer, Type A (accelerator is added)
Water reducer and retarder (ASTM C 494 and AASHTO M 194, Type D)	Reduce water content (minimum 5%) and retard set	See water reducer, Type A (retarder is added)
Water reducer—high range (ASTM C 494 and AASHTO M 194, Type F)	Reduce water content (minimum 12%)	See superplasticizers
Water reducer—high range—and retarder (ASTM C 494 and AASHTO M 194, Type G)	Reduce water content (minimum 12%) and retard set	See superplasticizers and also water reducers
Water reducer—mid range	Reduce water content (between 6 and 12%) without retarding	Lignosulfonates Polycarboxylates

* Superplasticizers are also referred to as high-range water reducers or plasticizers. These admixtures often meet both ASTM C 494 (AASHTO M 194) and ASTM C 1017 specifications.

The major reasons for using admixtures are:

1. To reduce the cost of concrete construction
2. To achieve certain properties in concrete more effectively than by other means
3. To maintain the quality of concrete during the stages of mixing, transporting, placing, and curing in adverse weather conditions
4. To overcome certain emergencies during concreting operations



Air-Entraining Admixtures

- used to purposely introduce and stabilize microscopic air bubbles in concrete. Air-entrainment will dramatically improve the durability of concrete exposed to cycles of freezing and thawing ([Fig. 6-2](#)). Entrained air greatly improves concrete's resistance to surface scaling caused by chemical de-icers



Frost damage at joints of a pavement



Frost induced cracking near joints

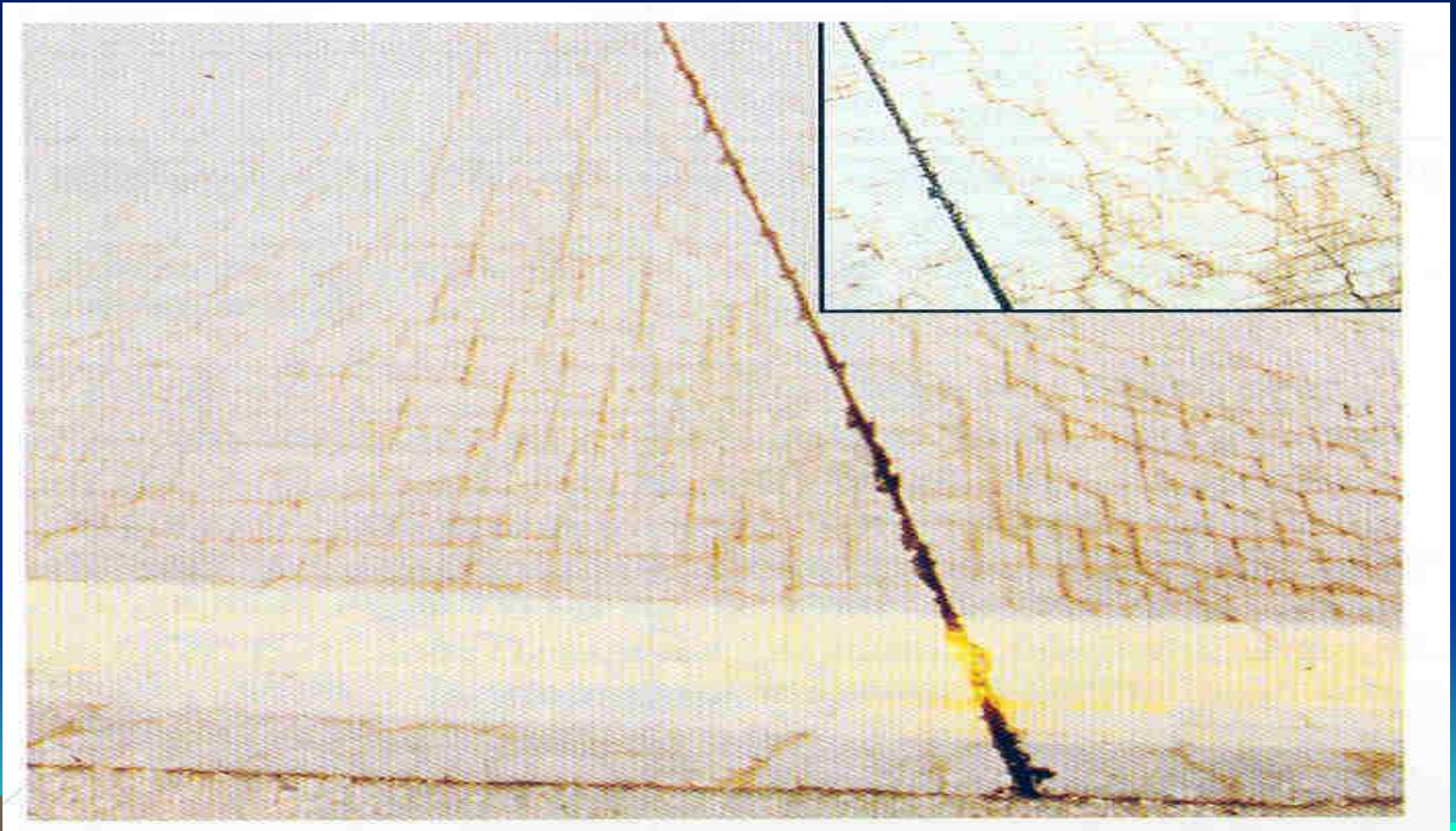

Scaled concrete surface resulting from lack of air entrainment, use of deicers, and poor finishing and curing practices



- The primary ingredients used in air-entraining admixtures are salts of wood resin (Vinsol resin), synthetic detergents, salts of petroleum acids, etc.

See Table 6-1 p.106 in the text for more details.



Water-Reducing Admixtures

- used to reduce the quantity of mixing water required to produce concrete of a certain slump, reduce water-cementing materials ratio, reduce cement content, or increase slump.
- Typical water reducers reduce the water content by approximately 5% to 10%.



Water-Reducing Admixtures

- Materials:
 - Lignosulfonates.
 - Carbohydrates.
 - Hydroxylated carboxylic acids.



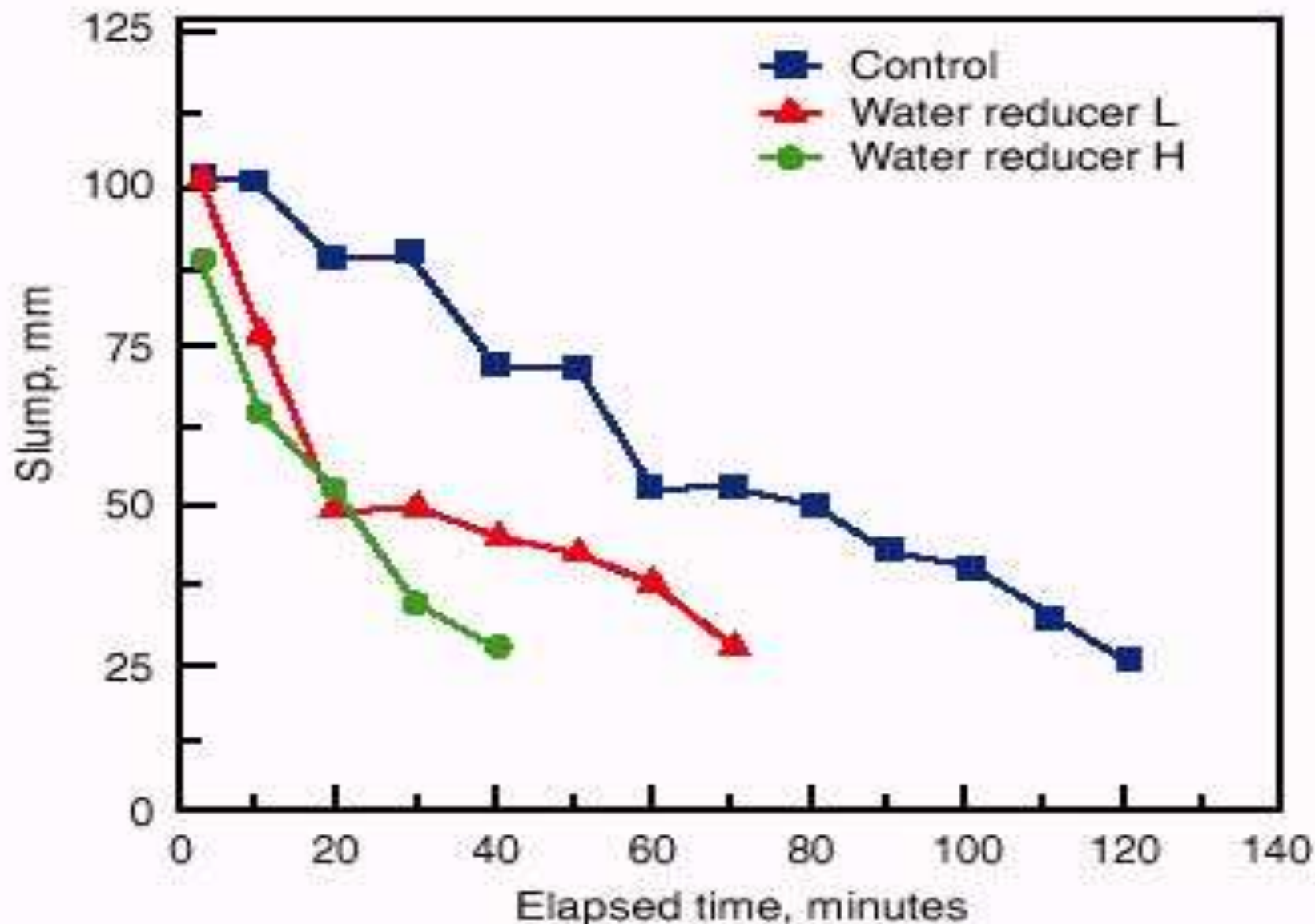

Fig. 6-4. Slump loss at 23°C in mixtures containing conventional water reducers (ASTM C 494, Type D) compared with a control mixture (Whiting and Dzedzic 1992).

Water-Reducing Admixtures

- The effectiveness of water reducers on concrete is a function of their chemical composition, concrete temperature, cement composition and fineness, cement content, and the presence of other admixtures.



Superplasticizers (High-Range Water Reducers)

- These admixtures are added to concrete with a low-to-normal slump and water-cementing materials ratio to make high-slump flowing concrete.
- Flowing concrete is a highly fluid but workable concrete that can be placed with little or no vibration or compaction while still remaining essentially free of excessive bleeding or segregation.



Superplasticizers (High-Range Water Reducers)

- Applications where flowing concrete is used:
 1. thin-section placements,
 2. areas of closely spaced and congested reinforcing steel,
 3. pumped concrete to reduce pump pressure, thereby increasing lift and distance capacity,
 4. areas where conventional consolidation methods are impractical or can not be used, and
 5. for reducing handling costs.



Flowable concrete with high slump



Is easily placed



Even in areas of heavy reinforcing steel congestion



- Low water to cement ratio concrete with low chloride permeability--- easily made with high-range water reducers- is ideal for bridge decks



- Plasticized, flowing concrete is easily placed in thin sections



Superplasticizers (High-Range Water Reducers)

- Typical superplasticizers include:
 - Sulfonated melamine formaldehyde condensates.
 - Sulfonated naphthalene formaldehyde condensate.
 - Lignosulfonates.
 - Polycarboxylates.



Superplasticizers (High-Range Water Reducers)

- bleed significantly less than control concretes of equally high slump and higher water content.
- High-slump, low-water-content, plasticized concrete has less drying shrinkage than a high-slump, high-water-content conventional concrete.
- has similar or higher drying shrinkage than conventional low-slump, low-water-content concrete.
- The effectiveness of the plasticizer is increased with an increasing amount of cement and fines in the concrete.



Retarding Admixtures

- used to retard the rate of setting of concrete at high temperatures of fresh concrete (30°C or more).
- One of the most practical methods of counteracting this effect is to reduce the temperature of the concrete by cooling the mixing water or the aggregates.
- Retarders do not decrease the initial temperature of concrete.
- The bleeding rate and capacity of plastic concrete is increased with retarders.



Retarding Admixtures

- The typical materials used as retarders are:
 - Lignin,
 - Borax,
 - Sugars,
 - Tartaric acid and salts.



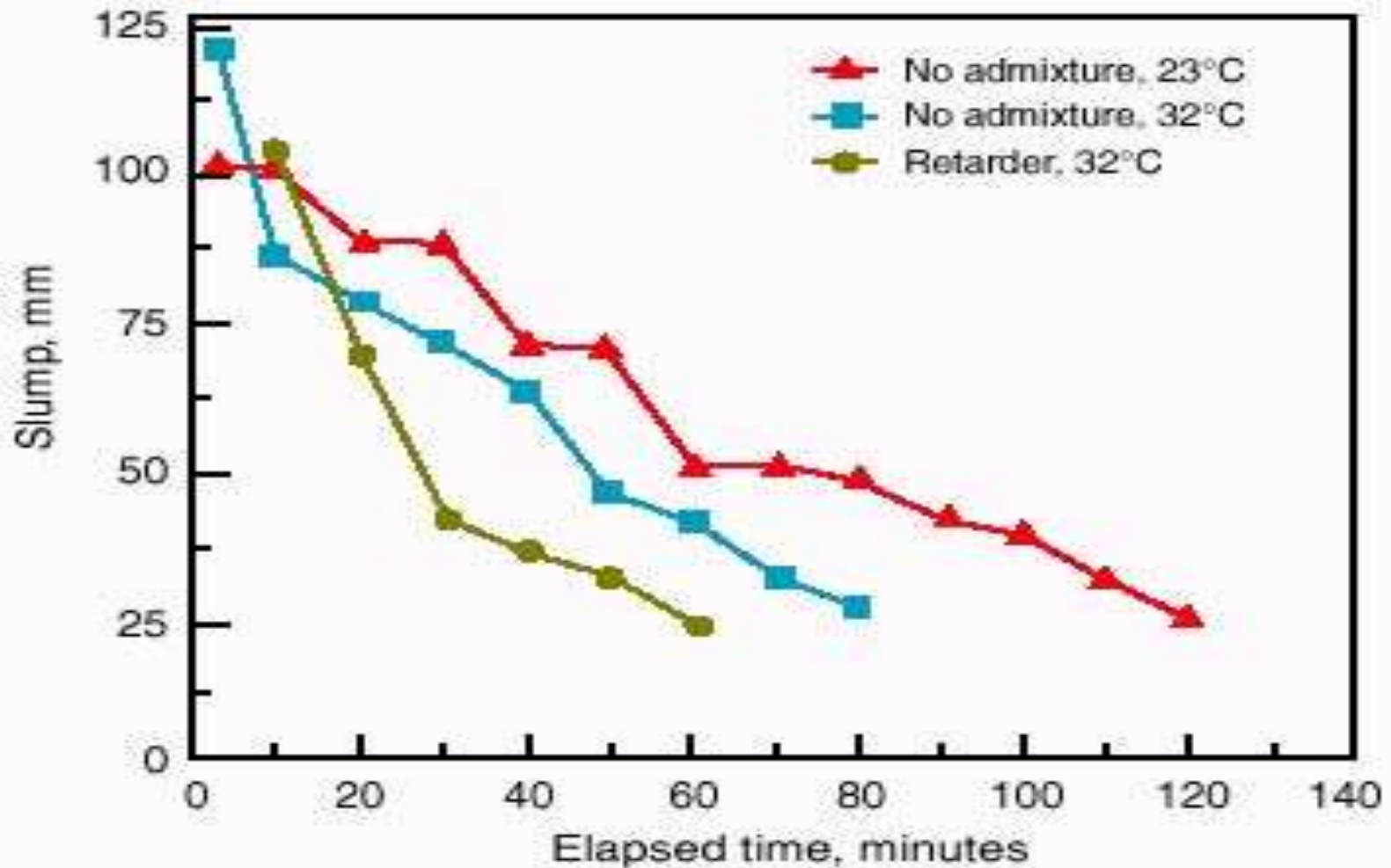

Fig. 6-15. Slump loss at various temperatures for conventional concretes prepared with and without set-retarding admixture (Whiting and Dziedzic 1992).

Retarding Admixtures

- Retarders are used to:
 1. offset the accelerating effect of hot weather on the setting of concrete,
 2. delay the initial set of concrete when difficult or unusual conditions of placement occur,
 3. delay the set for special finishing processes such as an exposed aggregate surface.



Retarding Admixtures

- some reduction in strength at early ages (one to three days) accompanies the use of retarders.
- The effects of these materials on the other properties of concrete, such as shrinkage, may not be predictable.

Therefore, acceptance tests of retarders should be made with actual job materials under anticipated job conditions.



Accelerating Admixtures

- used to accelerate strength development of concrete at an early age.
- Typical Materials are:
 - Calcium chloride: most commonly used for plain concrete.
 - Triethanolamine.
 - Calcium formate.
 - Calcium nitrate.
 - Calcium nitrite.



Corrosion Inhibitors



Fig. 6-16. The damage to this concrete parking structure resulted from chloride-induced corrosion of steel reinforcement. (50051)

Corrosion Inhibitors

- The chlorides can cause corrosion of steel reinforcement in concrete.
- Ferrous oxide and ferric oxide form on the surface of reinforcing steel in concrete.
- Ferrous oxide reacts with chlorides to form complexes that move away from the steel to form **rust**. The chloride ions continue to attack the steel until the passivating oxide layer is destroyed.



Corrosion Inhibitors

- Corrosion-inhibiting admixtures chemically arrest the corrosion reaction.
- Commercially available corrosion inhibitors include:
 - calcium nitrite,
 - sodium nitrite,
 - dimethyl ethanolamine,
 - amines,
 - phosphates,
 - ester amines.



Shrinkage-Reducing Admixtures

- Shrinkage cracks, such as shown on this bridge deck, can be reduced with the use of good concreting practices and shrinkage reducing admixtures.

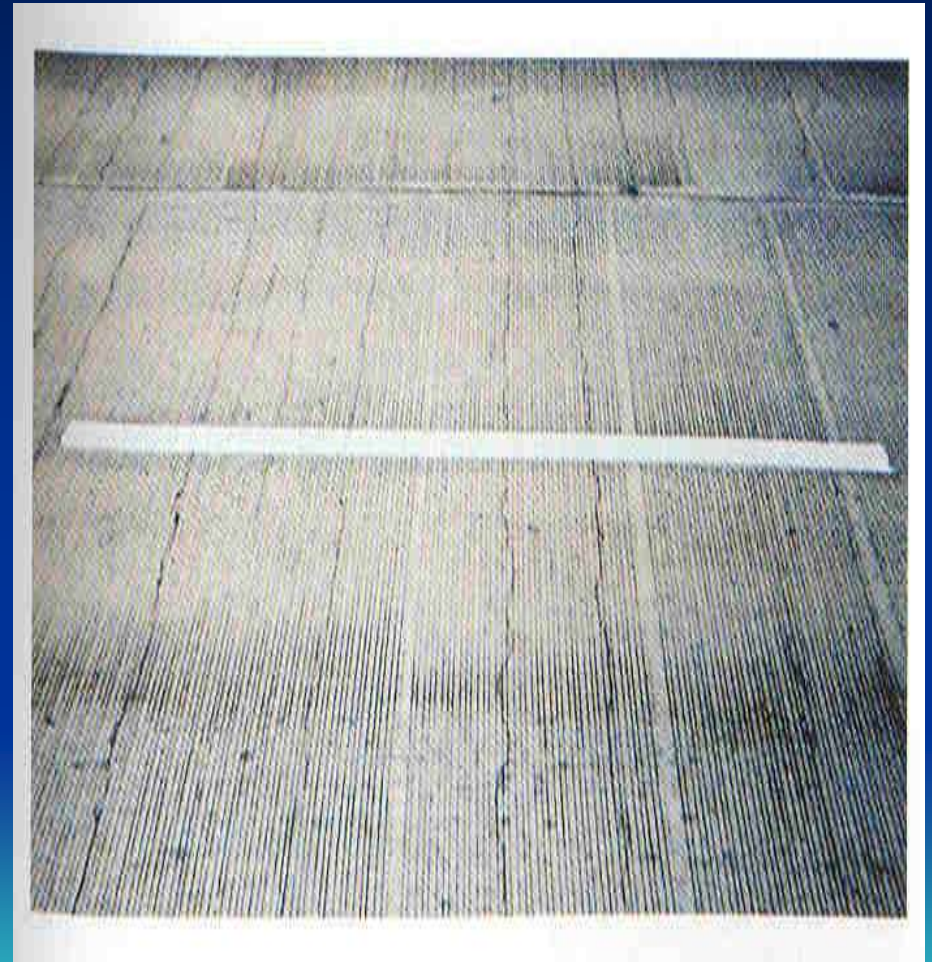

Chemical Admixtures to reduce Alkali-aggregate Reactivity (ASR Inhibitors)

- Expansion of specimens made with lithium carbonate admixture

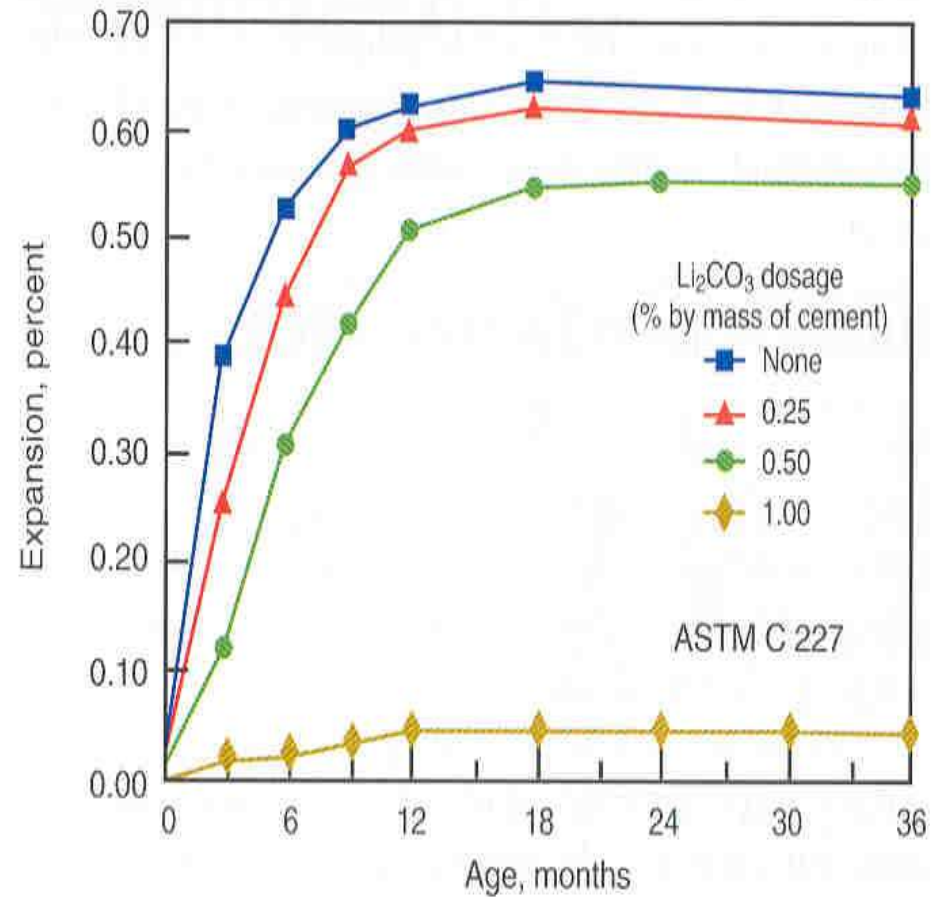

Coloring admixtures (Pigments)

- Red and blue pigments were used to color this floor



THANK YOU



Unit-II : Admixtures and Their Effects



Admixtures



Fig. 6-1. Liquid admixtures, from left to right: antiwashout admixture, shrinkage reducer, water reducer, foaming agent, corrosion inhibitor, and air-entraining admixture. (69795)

Admixtures are those ingredients in concrete other than Portland cement, water, and aggregates that are added to the mixture immediately before or during mixing ([Fig. 6-1](#)). Admixtures can be classified by function as follows:



1. Air-entraining admixtures
2. Water-reducing admixtures
3. Plasticizers
4. Accelerating admixtures
5. Retarding admixtures
6. Hydration-control admixtures



7. Corrosion inhibitors
8. Shrinkage reducers
9. Alkali-silica reactivity inhibitors
10. Colouring admixtures
11. Miscellaneous admixtures such workability, bonding, damp proofing, permeability reducing, grouting, gas-forming, and pumping admixtures



Table 6-1. Concrete Admixtures by Classification

Type of admixture	Desired effect	Material
Accelerators (ASTM C 494 and AASHTO M 194, Type C)	Accelerate setting and early-strength development	Calcium chloride (ASTM D 98 and AASHTO M 144) Triethanolamine, sodium thiocyanate, calcium formate, calcium nitrite, calcium nitrate
Air detrainers	Decrease air content	Tributyl phosphate, dibutyl phthalate, octyl alcohol, water-insoluble esters of carbonic and boric acid, silicones
Air-entraining admixtures (ASTM C 260 and AASHTO M 154)	Improve durability in freeze-thaw, deicers, sulfate, and alkali-reactive environments Improve workability	Salts of wood resins (Vinsol resin), some synthetic detergents, salts of sulfonated lignin, salts of petroleum acids, salts of proteinaceous material, fatty and resinous acids and their salts, alkylbenzene sulfonates, salts of sulfonated hydrocarbons
Alkali-aggregate reactivity inhibitors	Reduce alkali-aggregate reactivity expansion	Barium salts, lithium nitrate, lithium carbonate, lithium hydroxide
Antiwashout admixtures	Cohesive concrete for underwater placements	Cellulose, acrylic polymer
Bonding admixtures	Increase bond strength	Polyvinyl chloride, polyvinyl acetate, acrylics, butadiene-styrene copolymers
Coloring admixtures (ASTM C 979)	Colored concrete	Modified carbon black, iron oxide, phthalocyanine, umber, chromium oxide, titanium oxide, cobalt blue
Corrosion inhibitors	Reduce steel corrosion activity in a chloride-laden environment	Calcium nitrite, sodium nitrite, sodium benzoate, certain phosphates or fluosilicates, fluoaluminates, ester amines
Dampproofing admixtures	Retard moisture penetration into dry concrete	Soaps of calcium or ammonium stearate or oleate Butyl stearate Petroleum products
Foaming agents	Produce lightweight, foamed concrete with low density	Cationic and anionic surfactants Hydrolyzed protein
Fungicides, germicides, and insecticides	Inhibit or control bacterial and fungal growth	Polyhalogenated phenols Dieldrin emulsions Copper compounds
Gas formers	Cause expansion before setting	Aluminum powder
Grouting admixtures	Adjust grout properties for specific applications	See Air-entraining admixtures, Accelerators, Retarders, and Water reducers
Hydration control admixtures	Suspend and reactivate cement hydration with stabilizer and activator	Carboxylic acids Phosphorus-containing organic acid salts
Permeability reducers	Decrease permeability	Latex Calcium stearate
Pumping aids	Improve pumpability	Organic and synthetic polymers Organic flocculents Organic emulsions of paraffin, coal tar, asphalt, acrylics Bentonite and pyrogenic silicas Hydrated lime (ASTM C 141)
Retarders (ASTM C 494 and AASHTO M 194, Type B)	Retard setting time	Lignin Borax Sugars Tartaric acid and salts
Shrinkage reducers	Reduce drying shrinkage	Polyoxyalkylene alkyl ether Propylene glycol
Superplasticizers* (ASTM C 1017, Type 1)	Increase flowability of concrete Reduce water-cement ratio	Sulfonated melamine formaldehyde condensates Sulfonated naphthalene formaldehyde condensates Lignosulfonates Polycarboxylates

Table 6-1. Concrete Admixtures by Classification (Continued)

Type of admixture	Desired effect	Material
Superplasticizer* and retarder (ASTM C 1017, Type 2)	Increase flowability with retarded set Reduce water-cement ratio	See superplasticizers and also water reducers
Water reducer (ASTM C 494 and AASHTO M 194, Type A)	Reduce water content at least 5%	Lignosulfonates Hydroxylated carboxylic acids Carbohydrates (Also tend to retard set so accelerator is often added)
Water reducer and accelerator (ASTM C 494 and AASHTO M 194, Type E)	Reduce water content (minimum 5%) and accelerate set	See water reducer, Type A (accelerator is added)
Water reducer and retarder (ASTM C 494 and AASHTO M 194, Type D)	Reduce water content (minimum 5%) and retard set	See water reducer, Type A (retarder is added)
Water reducer—high range (ASTM C 494 and AASHTO M 194, Type F)	Reduce water content (minimum 12%)	See superplasticizers
Water reducer—high range—and retarder (ASTM C 494 and AASHTO M 194, Type G)	Reduce water content (minimum 12%) and retard set	See superplasticizers and also water reducers
Water reducer—mid range	Reduce water content (between 6 and 12%) without retarding	Lignosulfonates Polycarboxylates

* Superplasticizers are also referred to as high-range water reducers or plasticizers. These admixtures often meet both ASTM C 494 (AASHTO M 194) and ASTM C 1017 specifications.

The major reasons for using admixtures are:

1. To reduce the cost of concrete construction
2. To achieve certain properties in concrete more effectively than by other means
3. To maintain the quality of concrete during the stages of mixing, transporting, placing, and curing in adverse weather conditions
4. To overcome certain emergencies during concreting operations



Air-Entraining Admixtures

- used to purposely introduce and stabilize microscopic air bubbles in concrete. Air-entrainment will dramatically improve the durability of concrete exposed to cycles of freezing and thawing ([Fig. 6-2](#)). Entrained air greatly improves concrete's resistance to surface scaling caused by chemical de-icers



Frost damage at joints of a pavement



Frost induced cracking near joints

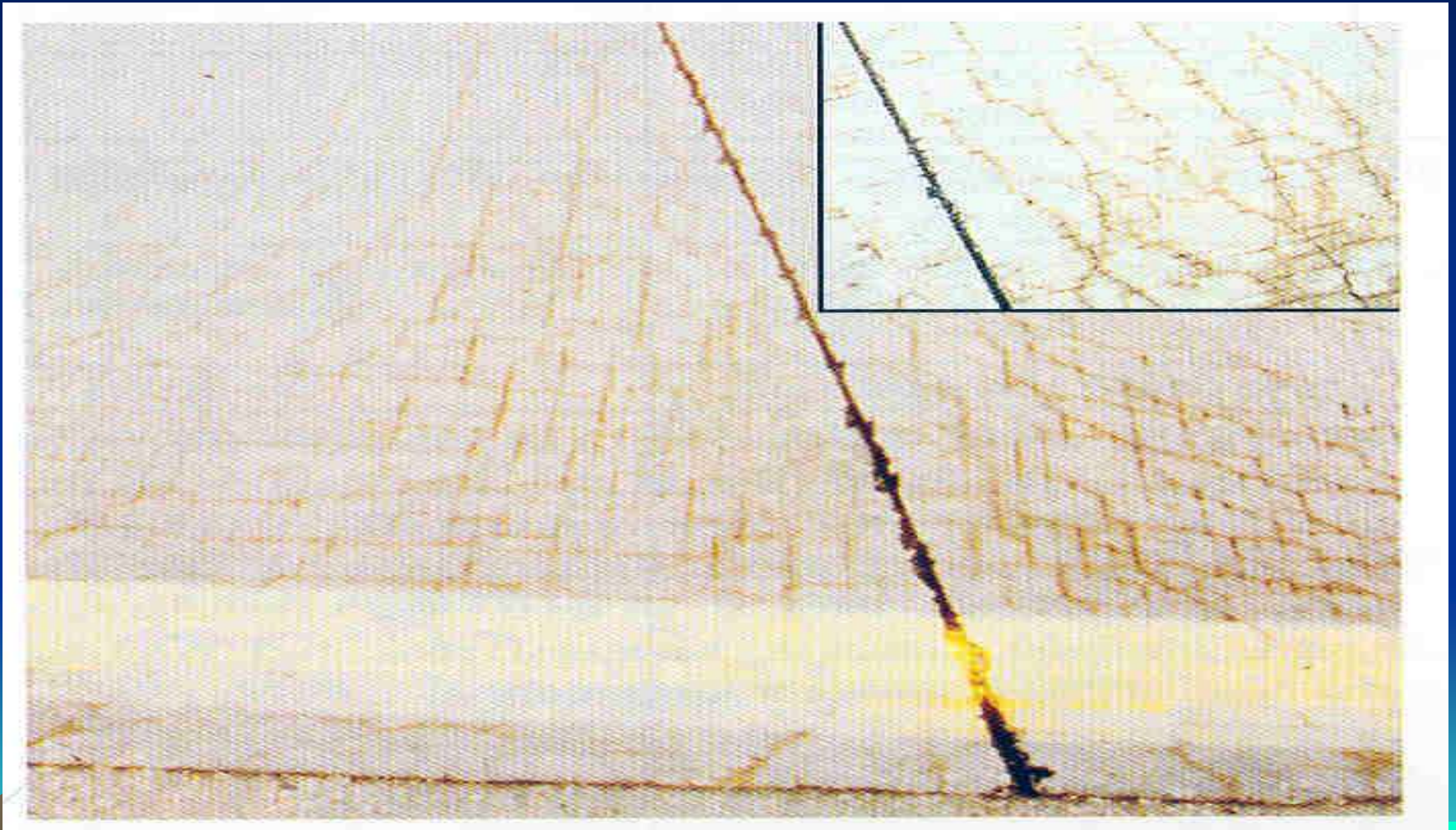

Scaled concrete surface resulting from lack of air entrainment, use of deicers, and poor finishing and curing practices



- The primary ingredients used in air-entraining admixtures are salts of wood resin (Vinsol resin), synthetic detergents, salts of petroleum acids, etc.

See Table 6-1 p.106 in the text for more details.



Water-Reducing Admixtures

- used to reduce the quantity of mixing water required to produce concrete of a certain slump, reduce water-cementing materials ratio, reduce cement content, or increase slump.
- Typical water reducers reduce the water content by approximately 5% to 10%.



Water-Reducing Admixtures

- Materials:
 - Lignosulfonates.
 - Carbohydrates.
 - Hydroxylated carboxylic acids.



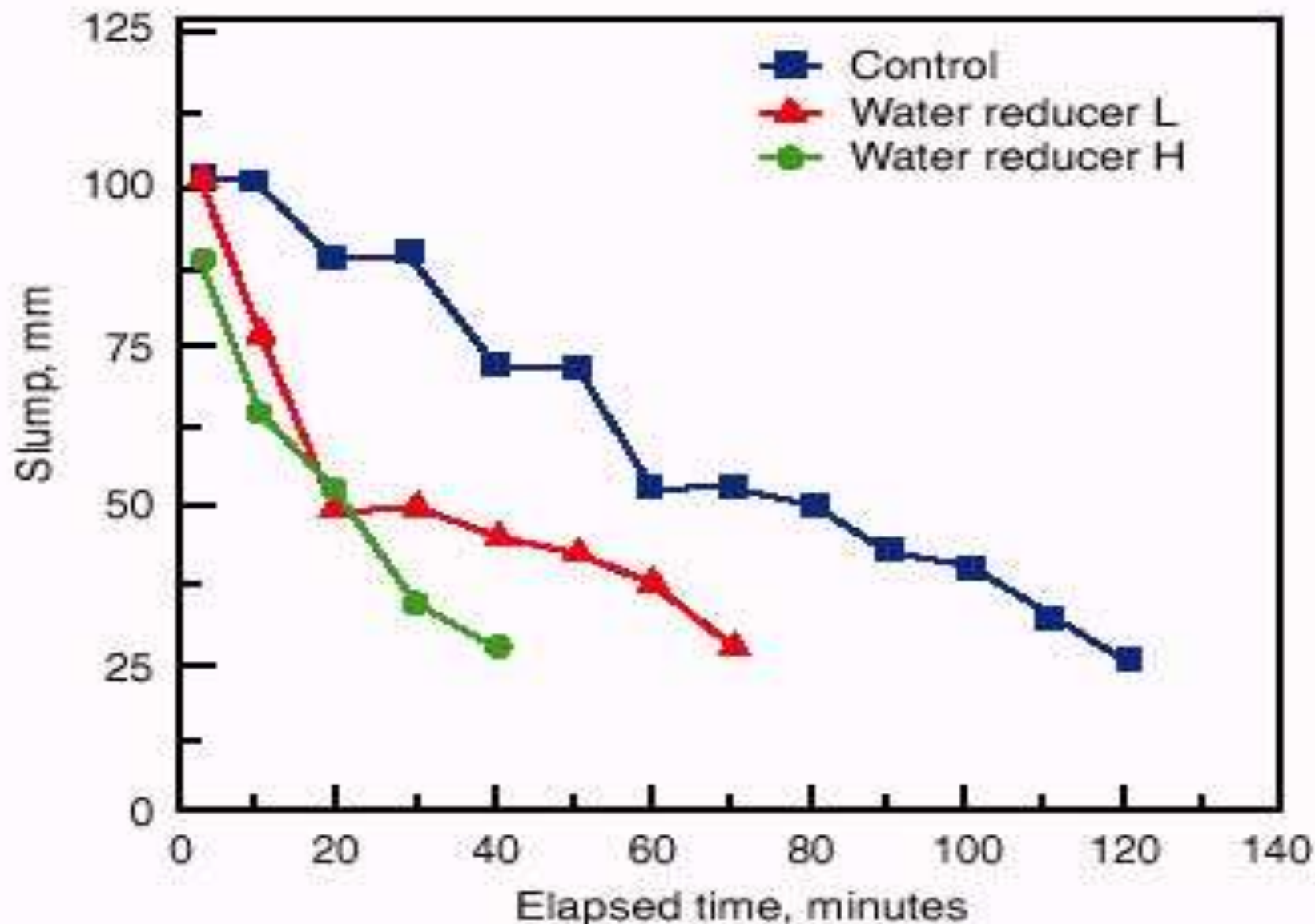

Fig. 6-4. Slump loss at 23°C in mixtures containing conventional water reducers (ASTM C 494, Type D) compared with a control mixture (Whiting and Dziedzic 1992).

Water-Reducing Admixtures

- The effectiveness of water reducers on concrete is a function of their chemical composition, concrete temperature, cement composition and fineness, cement content, and the presence of other admixtures.



Superplasticizers (High-Range Water Reducers)

- These admixtures are added to concrete with a low-to-normal slump and water-cementing materials ratio to make high-slump flowing concrete.
- Flowing concrete is a highly fluid but workable concrete that can be placed with little or no vibration or compaction while still remaining essentially free of excessive bleeding or segregation.



Superplasticizers (High-Range Water Reducers)

- Applications where flowing concrete is used:
 1. thin-section placements,
 2. areas of closely spaced and congested reinforcing steel,
 3. pumped concrete to reduce pump pressure, thereby increasing lift and distance capacity,
 4. areas where conventional consolidation methods are impractical or can not be used, and
 5. for reducing handling costs.



Flowable concrete with high slump



Is easily placed



Even in areas of heavy reinforcing steel congestion



- Low water to cement ratio concrete with low chloride permeability--- easily made with high-range water reducers- is ideal for bridge decks



- Plasticized, flowing concrete is easily placed in thin sections



Superplasticizers (High-Range Water Reducers)

- Typical superplasticizers include:
 - Sulfonated melamine formaldehyde condensates.
 - Sulfonated naphthalene formaldehyde condensate.
 - Lignosulfonates.
 - Polycarboxylates.



Superplasticizers (High-Range Water Reducers)

- bleed significantly less than control concretes of equally high slump and higher water content.
- High-slump, low-water-content, plasticized concrete has less drying shrinkage than a high-slump, high-water-content conventional concrete.
- has similar or higher drying shrinkage than conventional low-slump, low-water-content concrete.
- The effectiveness of the plasticizer is increased with an increasing amount of cement and fines in the concrete.



Retarding Admixtures

- used to retard the rate of setting of concrete at high temperatures of fresh concrete (30°C or more).
- One of the most practical methods of counteracting this effect is to reduce the temperature of the concrete by cooling the mixing water or the aggregates.
- Retarders do not decrease the initial temperature of concrete.
- The bleeding rate and capacity of plastic concrete is increased with retarders.



Retarding Admixtures

- The typical materials used as retarders are:
 - Lignin,
 - Borax,
 - Sugars,
 - Tartaric acid and salts.



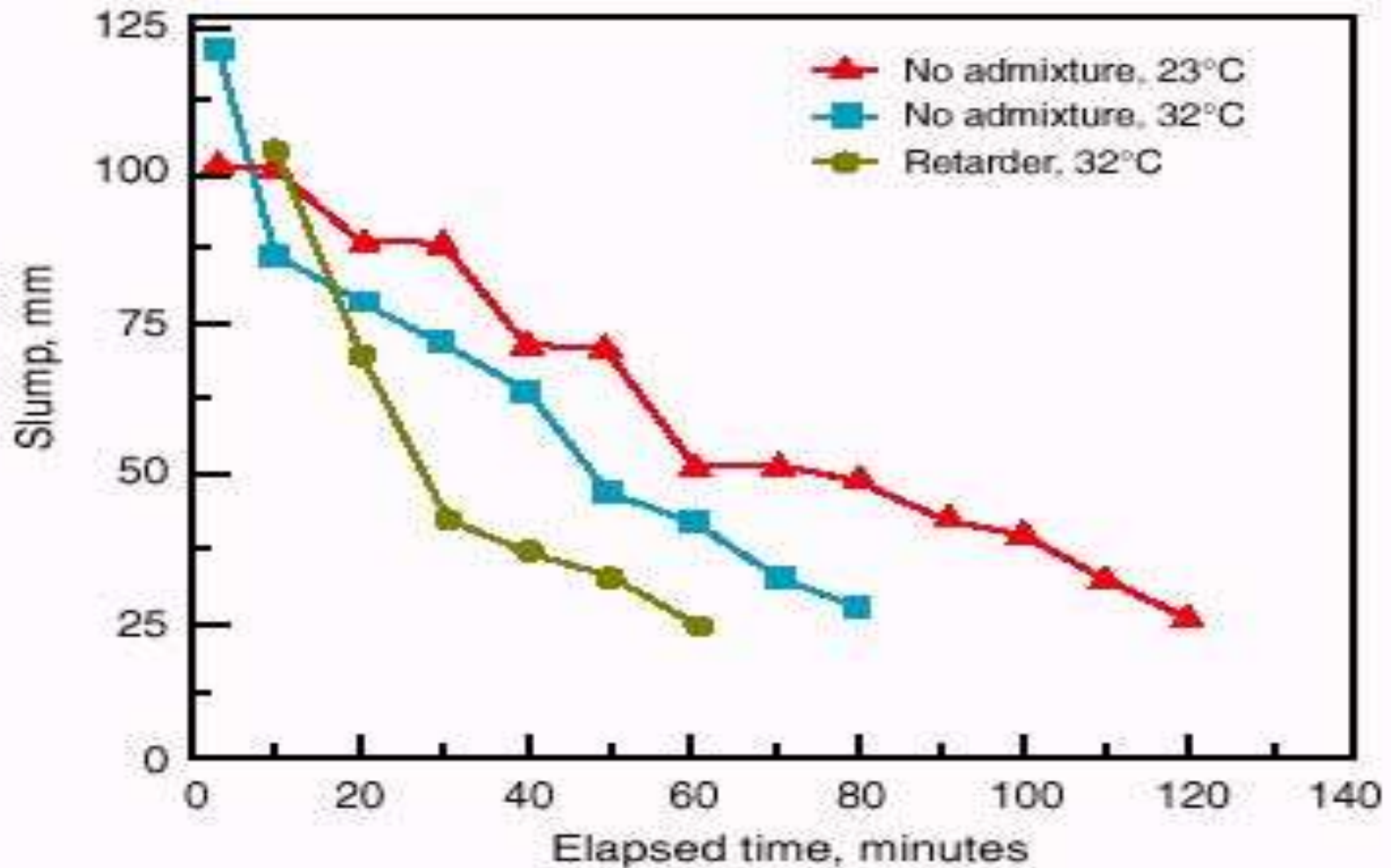

Fig. 6-15. Slump loss at various temperatures for conventional concretes prepared with and without set-retarding admixture (Whiting and Dziedzic 1992).

Retarding Admixtures

- Retarders are used to:
 1. offset the accelerating effect of hot weather on the setting of concrete,
 2. delay the initial set of concrete when difficult or unusual conditions of placement occur,
 3. delay the set for special finishing processes such as an exposed aggregate surface.



Retarding Admixtures

- some reduction in strength at early ages (one to three days) accompanies the use of retarders.
- The effects of these materials on the other properties of concrete, such as shrinkage, may not be predictable.

Therefore, acceptance tests of retarders should be made with actual job materials under anticipated job conditions.



Accelerating Admixtures

- used to accelerate strength development of concrete at an early age.
- Typical Materials are:
 - Calcium chloride: most commonly used for plain concrete.
 - Triethanolamine.
 - Calcium formate.
 - Calcium nitrate.
 - Calcium nitrite.



Corrosion Inhibitors



Fig. 6-16. The damage to this concrete parking structure resulted from chloride-induced corrosion of steel reinforcement. (50051)

Corrosion Inhibitors

- The chlorides can cause corrosion of steel reinforcement in concrete.
- Ferrous oxide and ferric oxide form on the surface of reinforcing steel in concrete.
- Ferrous oxide reacts with chlorides to form complexes that move away from the steel to form **rust**. The chloride ions continue to attack the steel until the passivating oxide layer is destroyed.



Corrosion Inhibitors

- Corrosion-inhibiting admixtures chemically arrest the corrosion reaction.
- Commercially available corrosion inhibitors include:
 - calcium nitrite,
 - sodium nitrite,
 - dimethyl ethanolamine,
 - amines,
 - phosphates,
 - ester amines.



Shrinkage-Reducing Admixtures

- Shrinkage cracks, such as shown on this bridge deck, can be reduced with the use of good concreting practices and shrinkage reducing admixtures.

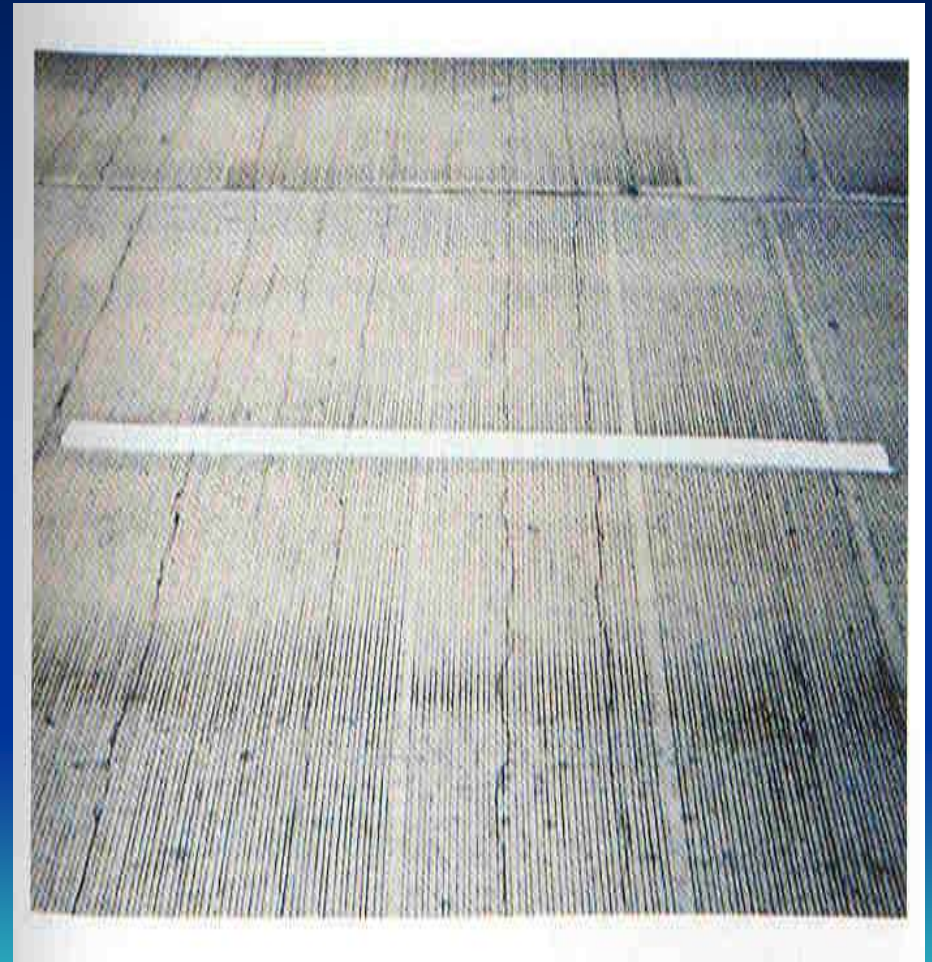

Chemical Admixtures to reduce Alkali-aggregate Reactivity (ASR Inhibitors)

- Expansion of specimens made with lithium carbonate admixture

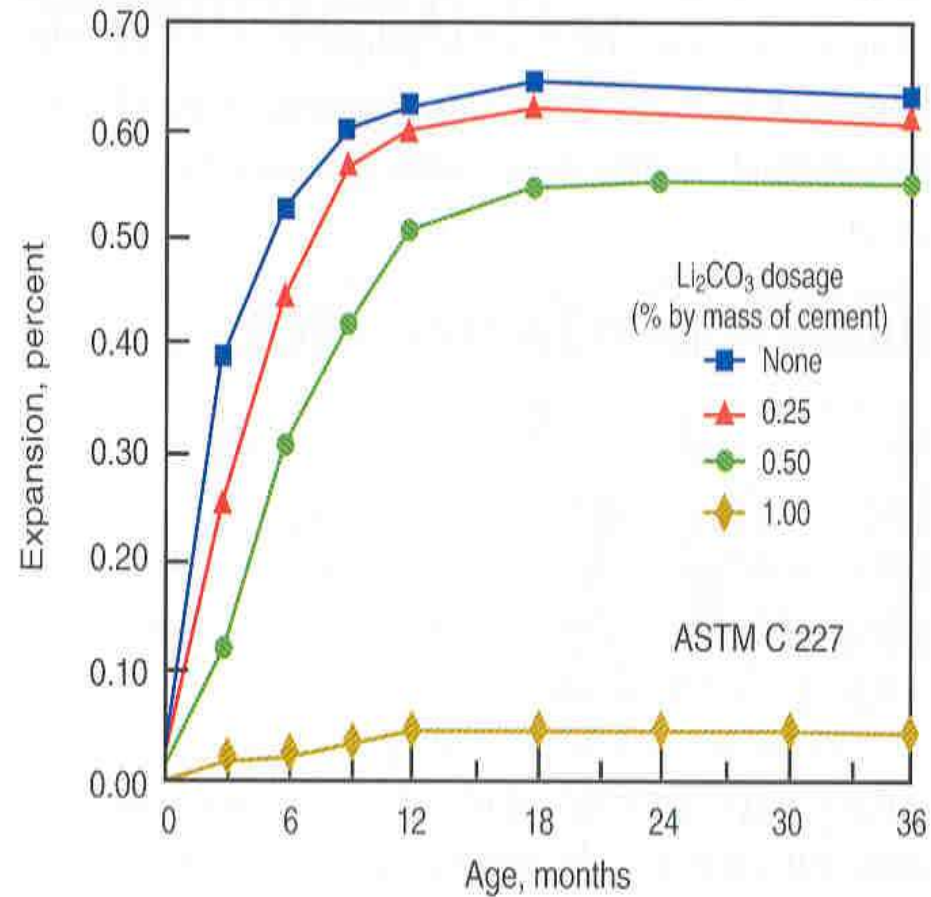

Coloring admixtures (Pigments)

- Red and blue pigments were used to color this floor



Unit-III : Proportioning of Concrete Mix

MIX-DESIGN

- The mix design procedure mainly involves determination of the proportions of the constituents of concrete i.e. Cement, Water, Coarse and Fine Aggregates, which results in the production of concrete that would have specified properties both in the fresh and hardened states with maximum overall economy.

FACTORS IN THE CHOICE OF MIX DESIGN

Both IS: 456-2000 as well as IS: 1343 – 1980 envisages the concrete mix design be based on the following factors:

- a) Grade Designation
- b) Type of Cement
- c) Maximum Nominal Size of Aggregate
- d) Minimum Water-Cement Ratio
- e) Workability
- f) Minimum Cement Content

Grade Designation

The characteristic strength requirement of the concrete is determined by the grade designation. Depending upon the level of quality control, the concrete is designed for a target mean strength, which is somewhat higher than the characteristic strength.

Type of Cement

Type of cement influences the rate of development of compressive strength of concrete and determines the durability under aggressive environment. The various types of cements that can be used with the approval of Engineer in Charge in concrete constructions are:

- Ordinary or low heat Portland cement conforming to IS : 269-1976
- Rapid hardening Portland cement conforming to IS : 8041-1978
- Portland slag cement conforming to IS : 455-1976
- Portland pozzolana cement conforming to IS : 1489-1976[8]
- High strength ordinary Portland cement conforming to IS : 8112-1976
- Hydrophobic cement conforming to IS : 8043-1978

Workability

Workability is important for the satisfactory placement and compaction of concrete with respect to size and shape of the section, quantity and spacing of reinforcement and methods of compaction available at site.

Maximum Nominal Size of Aggregate

The maximum nominal size of aggregates to be used in concrete is governed by the size of the section and spacing of the reinforcement. Both IS : 456-2000 and IS : 1343-1980 specify that the nominal maximum size of coarse aggregate

- Should not be greater than one-fourth of the minimum thickness of the member.
- Should be restricted to 5 mm less than the minimum clear distance between main bars.
- Should be 5 mm less than the minimum cover to the reinforcement.
- Should be 5 mm less than the spacing between the cables, strands in case of pre-stressed concrete.

Minimum Cement Content

The maximum limit of cement content in the concrete has to be specified as concrete mixes with high cement content may give rise to shrinkage, cracking and creep of concrete also increases with cement paste content.

OUTLINE OF MIX DESIGN PROCEEDURE

1. Data For Mix Proportioning

- a) Grade Designation
- b) Type of Cement
- c) Maximum nominal Size of Aggregate
- d) Minimum Cement Content
- e) Maximum Water Cement Ratio
- f) Workability
- g) Exposure Conditions as per Table 4 and 5 of IS 456 – 2000
- h) Maximum Temperature of Concrete at the time of placing
- i) Method of transporting and placing
- j) Early age strength requirements if required
- k) Type of Aggregate
- l) Maximum Cement Content
- m) Whether an admixture shall or shall not be used and the type of admixture and the conditions of use.

2 Target Strength For Mix Proportioning

In order that not more than the specified proportions of test results are not likely to fall below the **Characteristic Strength**, the Concrete Mix has to be proportioned for higher Target Mean Compressive Strength f'_{ck} . The margin over Characteristic Strength is given by the following relation:

$$f'_{ck} = f_{ck} + 1.65 S$$

Where

f'_{ck} = Target Mean Compressive Strength at 28 days in N/mm^2

f_{ck} = Characteristic Compressive Strength at 28 days in N/mm^2

S = Standard Deviation as given in table 1

Standard Deviation

Where Sufficient test results for a particular grade of concrete are not available then the value of Standard Deviation given in Table 1 may be assumed for the proportioning of the mix.

Table 1 Assumed Standard Deviation

S. No	Grade of Concrete	Assumed Standard Deviation N/mm ²
1	M 10	3.5
	M 15	
2	M 20	4.0
	M 25	
3	M 30	5.0
	M 35	
	M 40	
	M 45	
	M 50	
	M 55	

Note:- The above values corresponds to the site control having proper storage of cement; Weigh batching of all materials; Controlled addition of water; Regular checking of all materials -Aggregate grading and moisture content; Periodical checking of workability and strength. Where there is deviation from the above, values given in table shall be increased by 1 N/mm²

3 Selection Of Mix Proportion

3.1 Selection of Water Cement Ratio

Concretes of Different Compressive Strength for the Same Water Cement Ratio may be Produced with Different

- i. Cements
- ii. Supplementary Cementitious Materials
- iii. Aggregates of Different Sizes
- iv. Grading
- v. Surface Texture
- vi. Shape and other Characteristics

- Therefore, the relationship between strength and free W/C ratio should preferably be established for the materials actually to be used.
- In the absence of such data, the W/C Ratio given in Table 5 of IS 456 – 2000 for respective environmental exposure conditions may be used

NOTE: - *The supplementary cementitious material, that is mineral admixtures shall also be considered in W/C Ratio calculations in accordance with Table 5 of IS 456 – 2000*

3.2 Selection of Water Content

The Water content of concrete is influenced by a number of factors such as:

- a) **Aggregate Size**
- b) **Aggregate Shape**
- c) **Aggregate Texture**
- d) **Workability**
- e) **Water-Cement Ratio**
- f) **Type and Content of Cement and other supplementary Cementitious Materials**
- g) **Chemical Admixtures**
- h) **Environmental Conditions**

Water Demand is Reduced with

- a) **An Increase in Aggregate Size**
- b) **A Reduction in W/C Ratio and Slump**
- c) **Use of Rounded Aggregate**
- d) **Use of Water Reducing Admixtures**

On the other hand Water Demand is Increased Due to Increase in

- a) **Temperature**
- b) **Cement Content**
- c) **Slump and W/C Ratio**
- d) **Aggregate Angularity**
- e) **Decrease in the Proportion of CA to FA**

- The Quantity of Maximum Water per Unit Volume of Concrete may be determined from **Table 2** of IS 10262 – 2009
- The Water Content is for
 - a) **Angular Aggregate**
 - b) **Slump Range of 25 to 50 mm**
- The Water Estimate in Table 2 can be Reduced to produce same Workability by Approximately
 - a) **10 Kg for Sub-Angular Aggregate**
 - b) **20 Kg for Gravel with some Crushed Particles**
 - c) **25 Kg for Rounded Gravel**
- For the desired Workability (**other than 25 to 50 mm Slump Range**) the desired Water Content may be established
 - ❖ **by an Increase in Water content by about 3 Percent for every additional 25 mm Slump**
 - ❖ **Alternatively by use of Chemical Admixtures Conforming to IS 9103**
- **Water Reducing Admixtures or Superplasticizing Admixtures usually Decreases Water Content by 5 to 10% and 20% and above respectively at Appropriate Dosages**

Table 2 Maximum Water Content per Cubic Metre of Concrete for Nominal Maximum Size of Aggregate

S No.	Nominal maximum Size of Aggregate	Maximum Water Content
	<i>(mm)</i>	<i>(Kg)</i>
1	10	208
2	20	186
3	40	165

NOTE – These quantities of mixing water are for use in computing cementitious material contents for trial batches

Water Content corresponding to Saturated Surface Dry Aggregate

3.3 Calculation of Cementitious Material Content

- The Cement and other Supplementary Cementitious Material Content per Unit Volume Of Concrete may be calculated from
 - ❖ Free – Water Cement Ratio (see 3.1)
 - ❖ Quantity of Water per Unit Volume of Concrete
- The Cementitious Material Content so Calculated shall be checked against the Minimum Content for the Requirements of Durability and greater of the two values shall be adopted
- The Maximum Cement Content shall be in Accordance with IS 456.

3.4 Estimation of Coarse Aggregate Proportions

- Approximate Volume of Coarse Aggregate per unit Volume of Total Aggregate is given in **Table 3** for **W/C Ratio of 0.5** , which may be suitably adjusted for other W/C ratios.
- For equal workability, the volume of Coarse Aggregate is dependent only on
 - **Its Nominal Maximum Size**
 - **Grading Zone of Fine Aggregate**

Table 3 Volume of Coarse Aggregate per Unit Volume of Total Aggregate for Different Zones of Fine Aggregate

S. No.	Nominal Maximum Size of Aggregate	Volume of Coarse Aggregate per unit Volume of Total Aggregate for Different Zones of Fine Aggregate			
		Zone IV	Zone III	Zone II	Zone I
	mm				
i	10	0.50	0.48	0.46	0.44
ii	20	0.66	0.64	0.62	0.60
iii	40	0.75	0.73	0.71	0.69

Volumes are based aggregates in saturated surface dry condition

3.5 Combination of Different Coarse Aggregate Fractions

- The Coarse Aggregate Used Shall confirm to IS 383
- Coarse Aggregate of Different Sizes may be Combined in Suitable Proportions so as to Result in an overall Grading Conforming to **Table 2** of **IS 383** for particular Nominal Maximum Size of Aggregate

3.6 Estimation of Fine Aggregate Proportions

- With the completion of procedure given in 3.4 all the Ingredients have been estimated except the **Coarse** and **Fine** Aggregate content.
- These Quantities are Determined by Finding out Absolute Volume of
 - Cementitious Material**
 - Water**
 - Chemical Admixture**
 - By Dividing their Mass by their Respective Specific Gravity**
 - Multiplying by 1/1000**
 - And Subtracting the result of their summation from Unit Volume**
- The Values so obtained are divided into Coarse and Fine Aggregate Fractions by Volume in Accordance with Coarse Aggregate Proportions determined in 3.4
- The Coarse and Fine Aggregate Contents are then determined by multiplying by their respective Specific gravities and then by 1000

AIMS OF MIX DESIGN

- Determination of most **APPROPRIATE PROPORTIONS** of constituents to meet the needs of construction
- **The Design Concrete Should**
 - ❖ Comply with structural **Strength Stipulations** i.e. **Compressive Strength**
 - ❖ Have Satisfactory **DURABILITY** in the Environment in which Structure is used
 - ❖ Have Satisfactory **APPEARANCE** where Exposed to View
 - ❖ Be of Suitable **WORKABILITY**
 - ❖ Be as **ECONOMICAL** as possible
- Choose **Economic Proportions** to Obtain a **Cohesive Concrete** of **Desired Strength, Workability and Durability** from **Available Materials**

- **ECONOMY**
- **For Specified Strength mixes requiring LEAST WATER also REQUIRE LEAST CEMENT CONTENT**
- **Following Conditions Contribute to Economy in General:**
 - ❑ **Use Largest Mean Size Aggregate (MSA) permissible, consistent with Handling & Placement facilities available**
 - ❑ **Use Aggr. With MOST FAVOURABLE PARTICLE SHAPE, Consistent with AVAILABILITY at REASONABLE COST**
 - ❑ **Use COARSEST GRADING & LOWEST CONTENT of F.A consistent with STABILITY & FINISHABILITY**
 - ❑ **Use LOWEST WORKABILITY consistent with ADEQUATE PLACEMENT & COMPACTION with AVAILABLE FACILITIES**

METHODS OF CONCRETE MIX DESIGN

- The mix design methods which are used in different countries are mostly based on empirical relationships, charts and graphs developed from extensive experimental investigations. Most of them follow the same basic principles and only minor differences exist in different mix-design methods for selecting the most appropriate mix proportion. Some of the mix design procedures are:
 - IS : 10262 – 1982
 - IRC: 44 – 1976 Method
 - Road Note No. 4 Method
 - ACI – 211.1 – 1976
 - USBR Method – 1968
 - High Strength Concrete Mixes [ACI Method]
 - Murdoch method
 - Arbitrary Proportions
 - Maxm. Density Method
 - Fineness Modulus Method
 - Surface Area Method

- The ACI method gives mix design for normal and heavy weight concrete in the
 - ❖ Workability range of 25 to 100 mm slump,
 - ❖ 28-day cylinder compressive strength of 45 N/mm².
- There is another method for mix design of
 - ❖ No slump concrete (slump being 0 to 25 mm) and
 - ❖ Maximum 28-day cylinder compressive strength of 47.5 N/mm².
- The British method outlines a procedure for design of normal concrete mixes having 28-day cube compressive strength as high as 75 N/mm² The workability is given in terms of slump value.
- In the USBR method mix proportioning is done only for air-entrained concrete for maximum 28-day cylinder compressive strength of 45.5 N/mm², when water reducing admixtures are added.

In all the above four methods, the W/C ratio is chosen for the target mean strength from empirical strength – w/c ratio relationships and water content is chosen for the required workability for aggregates in saturated surface (SSD) condition.

- The Indian Standard recommended guidelines for mix design includes design of normal concrete mixes both for medium and high strength concrete.
- In this method of mix design,
 - The water content and proportion of fine aggregate corresponding to a maximum size of aggregate are first determined for reference values of
 - ❖ **workability,**
 - ❖ **w/c ratio and**
 - ❖ **grading of fine aggregate.**
 - The water content and proportion of fine aggregate are then adjusted for any difference in
 - ❖ **workability,**
 - ❖ **w/c ratio and**
 - ❖ **grading of fine aggregate in any particular case from the reference values.**
 - The batch weight of materials per unit volume of concrete is finally calculated by the absolute volume method.

- The specific relationships (tables and figures) that are used in this method are arrived at by exhaustive tests at the 'Cement Research Institute of India as well as on the basis of data generated in the country for the design of concrete..

REFERENCES

- B.I.S. Handbook on Concrete Mixes, SP:23(S&T) – 1982 New Delhi, pp. 103 – 122
- B.I.S. Recommended Guidelines for Concrete Mix Design, IS:10262 – 1982, N. Delhi
- HMSO Design of Concrete Mixes, Road Research Laboratory, Road Note No. 4, London, 1950
- I.R.C. Tentative Guidelines for Cement Concrete Mix Design for Road Pavements, IRC:44 – 1976, N. Delhi
- A.C.I. Recommended Practice for Selecting Proportions for Normal Heavy Weight Concrete, ACI 211.1 – 77, Detroit.
- A.C.I. Recommended Practice for Selecting Proportions for No Slump Concrete, ACI 211-65, Detroit, ACI 211.3 – 75

CONCRETE MIX-DESIGN TO IS : 10262 – 2009

(1) STIPULATIONS for PROPORTIONING

- a) Grade Designation = 30 Mpa
- b) Type of Cement = OPC 43 Grade conforming to IS 8112
- c) Maximum Nominal Size of Aggregate = 20 mm (Angular)
- d) Minimum Cement Content = 320 Kg/m³
- e) Maximum W/C Ratio = 0.45
- f) Workability = 100 mm (Slump)
- g) Exposure Condition = Severe (For RCC Work)
- h) Degree of Supervision = Good
- i) Method Concrete Placing = Pumping
- j) Maximum Cement Content = 450 Kg/m³
- k) Chemical Admixture Used = Superplasticizer

2 TEST DATA FOR MATERIALS

- a) **Cement Used** = OPC 43 Grade Conforming to IS 8112
- b) **Specific gravity of Cement**= 3.15
- c) **Chemical Admixtures** = Superplasticizer conforming to IS 9103 (If Required)
- d) **Specific Gravity of:**
 - i) **Coarse Aggregate** = 2.74
 - ii) **Fine Aggregate** = 2.74
- e) **Water Absorption**
 - i) **Coarse Aggregate** = 0.5 Percent
 - ii) **Fine Aggregate** = 1.0 Percent
- f) **Free (Surface) Moisture**
 - i) **Coarse Aggregate** = Nil
 - ii) **Fine Aggregate** = Nil

Sieve Analysis

Coarse Aggregate

IS Sieve Size	Analysis of C.A. Fractions		Percentage of Different Fractions		
			I	II	Combined
(mm)	I	II	60 %	40 %	100 %
20	100	100	60	40	100
10	0	71.20	0	28.5	28.5
4.75	-	9.40	-	3.7	3.7
2.36	-	0	-	-	-
Remark: Conforming to Table 2 of IS : 383 – 1970					

Fine Aggregate : Conforming to Grading zone II of Table IV of IS:383-1970

SOLUTION

3 TARGET MEAN STRENGTH

In order that not more than the specified proportion of test results are likely to fall below the CHARACTERISTIC STRENGTH, the concrete mix has to be designed at somewhat HIGHER TARGET AVERAGE COMPRESSIVE STRENGTH σ_t

Target Mean strength is Given By

$$f'_{CK} = f_{CK} + 1.65 S \quad (1)$$

Where,

f'_{CK} = Target Mean Compressive Strength at 28 days in N/mm^2

f_{CK} = Characteristic Compressive Strength at 28 days in N/mm^2

S = Standard Deviation

From Table 1 Standard Deviation, $S = 5 N/mm^2$

Therefore

$$\text{Target Strength} = 30 + 1.65 \times 5 = 38.25 N/mm^2$$

NOTE: According to IS:456-1978 & 1343-1980 the Characteristic Strength is defined as that value below which not more than 5% (1 in 20) results are expected to fall.

4 SELECTION OF WATER-CEMENT RATIO

- From Table 5 IS 456 – 2000, **W/C Ratio = 0.45** [for M 30 and Severe Exposure Conditions]

5 SELECTION OF WATER CONTENT

- For 100 mm Slump [Workability]
- From Table 2 of IS 10262 – 2009;
 - ❖ **Maximum Water Content = 186 Litres** [For **25 to 50 mm Slump Range** and **20 mm MSA**]

Therefore

- ❖ **Estimated Water Content for 100 mm Slump = $186 + \frac{6}{10000} \times 186$**
= 197 Litres

Note: Increase water by 3% for every additional 25 mm Slump

TABLE :- 5 MINM. Cement Content, MAXM. W/C Ratio and Minm Grade of Concrete with different exposures with Normal Weight Aggregate of 20 mm Nominal Maxm Size[As per IS 456-2000]

<i>Exposure</i>	<i>Plain Concrete</i>			<i>Reinforced Concrete</i>		
	Minimum Cement Content (Kg/m ³)	Maximum Free W/C Ratio	Minimum Grade of Concrete	Minimum Cement Content (Kg/m ³)	Maximum Free W/C Ratio	Minimum Grade of Concrete
Mild	220	0.60	-	300	0.55	M 20
Moderate	240	0.60	M 15	300	0.50	M 25
Severe	250	0.50	M 20	320	0.45	M 30
Very Severe	260	0.45	M 20	340	0.45	M 35
Extreme	280	0.40	M 25	360	0.40	M 40

Notes:

1. Cement Content prescribed in this table is irrespective of the grades of cement and it is inclusive of additions mentioned in 5.2. The additions such as fly ash or ground granulated blast furnace slag may be taken into account in the concrete composition with respect to the cement content and W/C ratio if the suitability is established and as long as the maximum amounts taken into account do not exceed the limit of pozzolana and slag specified in IS 1489 (part 1) and IS 455 respectively
2. Minimum Grade of Concrete for plain concrete under mild exposure conditions is not specified

TABLE :- 6 Adjustments to Minimum Cement Contents for Aggregates Other Than 20 mm Nominal maximum Size [As per IS 456-2000]

S. No.	Nominal Maximum Aggregate Size	Adjustments to Minimum Cement Contents in Table 5
1	10	+40
2	20	0
3	40	-30

6 CALCULATION OF CEMENT CONTENT

➤ Water Cement Ratio $\underline{W/C} = 0.45$

➤ Cement Content = $\frac{1997}{0.45}$

= $\underline{438 \text{ Kg/m}^3}$

Note: From Table 5 of IS 456 – 2000 Minimum Cement Content for Severe Exposure Condition = 320 Kg/m^3

$438 \text{ Kg/m}^3 > 320 \text{ Kg/m}^3$ Hence OK

7 PROPORTION OF VOLUME of COARSE AGGREGATE AND FINE AGGREGATE CONTENT

From Table 3

For W/C Ratio = 0.5 and Zone II of FA

$\underline{\text{Volume of CA}} = 0.62$

Decrease in W/C Ratio = $0.5 - 0.45 = 0.05$

- In the present case there is a Decrease in W/C Ratio and hence
- CA is required to be **Increased** to Decrease the Fine Aggregate Content
- The Rate of increase = **-/+ 0.01** for every **± 0.05** Change in W/C Ratio

Therefore,

Corrected Proportion of Coarse Aggregate CA = 0.63

Proportion of Fine Aggregate = $1 - 0.63$ FA = 0.37

8 MIX CALCULATION

- The Mix Calculation Per Unit Volume of Concrete Shall be as Follows

(a) Volume of Concrete = 1 m^3

(b) Volume of Cement = $\frac{\text{Mass of Cement}}{\text{Specific Gravity of Cement}} \times \frac{1}{1000}$

$$= \frac{438}{3.15} \times \frac{1}{1000} = 0.139 \text{ m}^3$$

$$\begin{aligned}
 \text{(c) Volume of Cement} &= \frac{\text{Mass of Water}}{\text{Specific Gravity of Water}} \times \frac{1}{10000} \\
 &= \frac{1997}{1} \times \frac{1}{10000} = \underline{\underline{0.197 \text{ m}^3}}
 \end{aligned}$$

$$\text{(d) Volume of Admixture} = \frac{\text{Mass of Chemical Admixture}}{\text{Specific Gravity of Admixture}} \times \frac{1}{10000}$$

$$\begin{aligned}
 \text{(e) Volume of all in Aggregate} &= [a - (b + c + d)] \\
 &= [1 - (0.139 + 0.197 + 0)] \\
 &= \underline{\underline{0.664 \text{ m}^3}}
 \end{aligned}$$

$$\begin{aligned}
 \text{(f) Mass of Coarse Aggregate} &= e \times \text{Volume of CA} \times \text{Specific Gravity of CA} \times 1000 \\
 &= 0.664 \times 0.63 \times 2.74 \times 1000 \\
 &= \underline{\underline{1146 \text{ Kg}}}
 \end{aligned}$$

$$\begin{aligned}
 \text{(g) Mass of Fine Aggregate} &= e \times \text{Volume of FA} \times \text{Specific Gravity of FA} \times 1000 \\
 &= 0.664 \times 0.37 \times 2.74 \times 1000 \\
 &= \underline{\underline{673 \text{ Kg}}}
 \end{aligned}$$

MIX PROPORTIONS FOR TRIAL No. 1

Water

197 Litres

0.45

Cement

438 Kg

1

FA

673 Kg

1.54

CA

1146 Kg
(10 mm = 458 Kg)
(20 mm = 688 Kg)

2.62

Unit-IV : Fresh and Hardened Properties of Concrete

LECTURE#05

Fresh Concrete Properties & its Standard Tests

CE-106: Civil Engineering material and concrete technology

Instructor: Engr. Izaz Ahmad

*University of engineering and technology Peshawar
campus III Bannu*



Properties OF Fresh Concrete

Fresh Concrete:

It is the concrete phase from time of mixing to end of time concrete surface finished in its final location in the structure.

Concrete Operations:

They include batching, mixing, transporting, placing, compacting, surface finishing . Then curing of in-placed concrete starts 6-10 hours after casting (placing) and during first few days of hardening is important.

Properties OF Fresh Concrete

It is known that fresh state properties enormously affect hardened state properties due to the following reasons:

- The potential strength and durability(the ability to withstand wear, pressure, or damage.) of concrete of a given mix proportion is very dependent on the degree of its compaction(squeezing force).
- The first 48 hours are very important for the performance of the concrete structure.
- It controls the long-term behavior, influence f'_c (ultimate strength), E_c (elastic modulus), creep(Elastic deformations occur immediately after the **concrete** is subjected to a given load, according to Hooke's Law. Inelastic deformations increase with time as the **concrete** experiences a sustained load. This inelastic deformation, also known as **creep**, increases at a decreasing rate during the loading period.
-), and durability.

Properties OF Fresh Concrete

- **Elasticity and Strength Of Concrete**
 - The elastic properties of materials are a measure of their resistance to deformation under an applied load (but the elastic strain is recovered when the load is removed).
 - Strength usually refers to the maximum stress that a given kind of sample can carry.
 - Understanding these properties and how they are measured is essential for anyone wishing to use materials

Main Prop. OF Fresh Concrete

Consistency

- Slump Test
- Flow Test
- Penetration Test

Workability

- Compacting Factor Test
- VeBe Time Test

Segregation

- ---
- ---

Bleeding

- Bleeding Water Test

Concrete Consistency

Concrete Consistency

The ability of freshly mixed concrete or mortar to flow; the usual measurements are slump for concrete, flow for mortar or grout, and penetration resistance for neat cement paste.



Concrete Consistency

- **Consistency** is the aspect of workability related to the flow characteristics of fresh concrete. It is an indication of the fluidity or wetness of a mix and is measured by the slump test
- However, it must not be assumed that the wetter the mix the more workable it is. If a mix is too wet, segregation may occur with resulting honeycomb, excessive bleeding, and sand streaking on the formed surfaces

Concrete Consistency

- On the other hand, if a mix is too dry it may be difficult to place and compact, and segregation may occur because of lack of cohesiveness and plasticity of the paste.



3 Ways to determine Consistency of Fresh Concrete

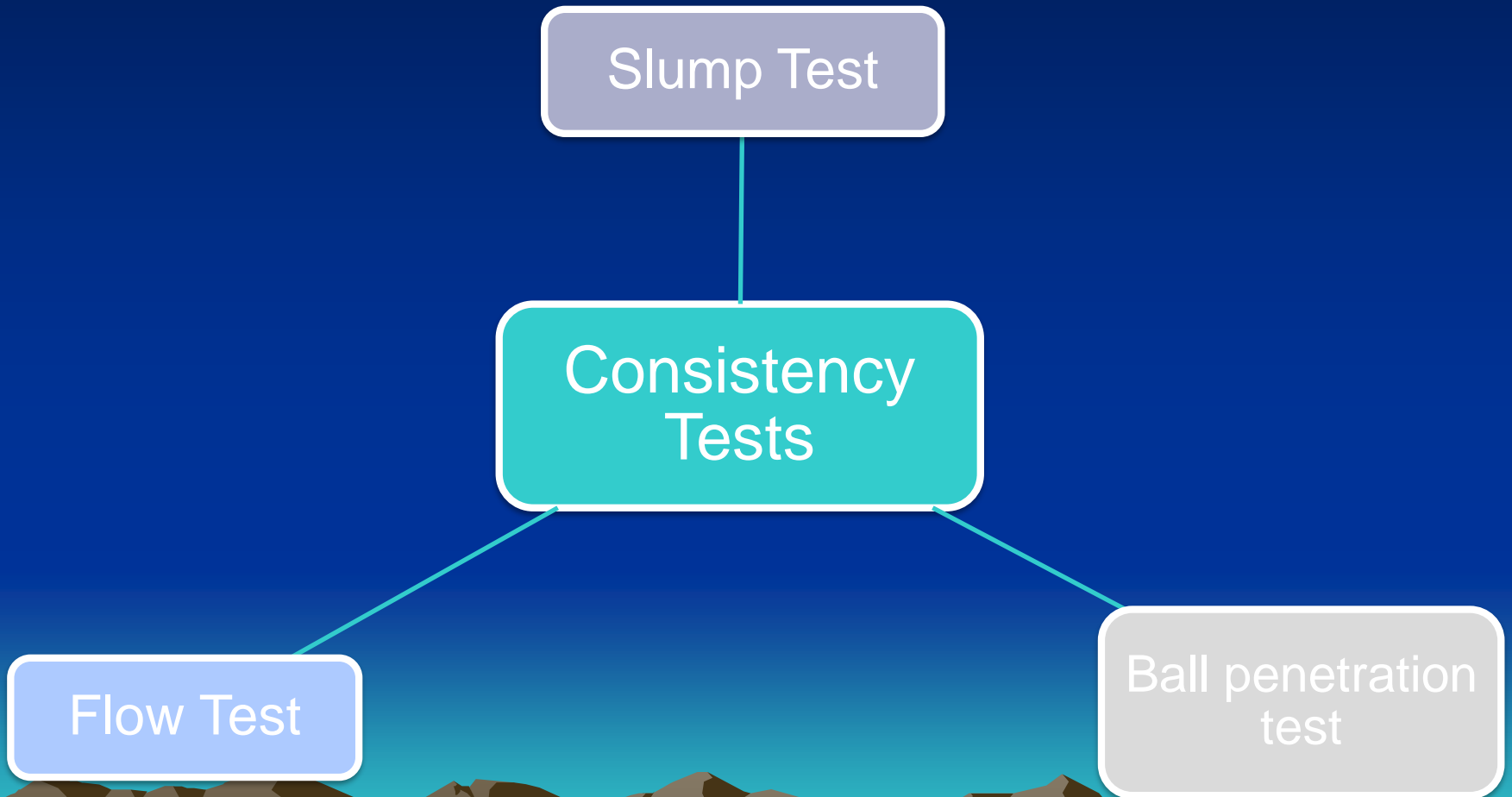

Slump Test

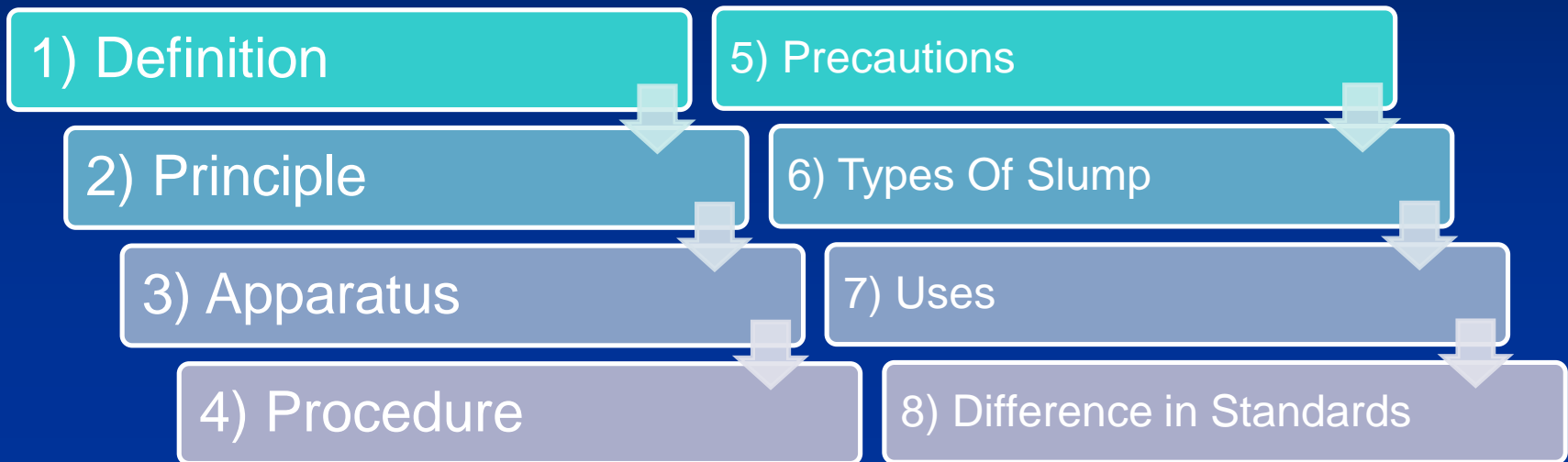

Slump Test

Definition

A slump test is a method used to determine the consistency of concrete. The consistency, or stiffness, indicates how much water has been used in the mix. The stiffness of the concrete mix should be matched to the requirements for the finished product quality

- Slump is a measurement of concrete's workability, or fluidity.

Principle

The slump test result is a measure of the behavior of a compacted inverted cone of concrete under the action of gravity. It measures the consistency or the wetness of concrete.

Slump Test

- **Apparatus**

- Slump cone : frustum of a cone, 300 mm (12 in) of height. The base is 200 mm (8in) in diameter and it has a smaller opening at the top of 100 mm
- Scale for measurement,
- Temping rod(steel) 15mm diameter, 60cm length.

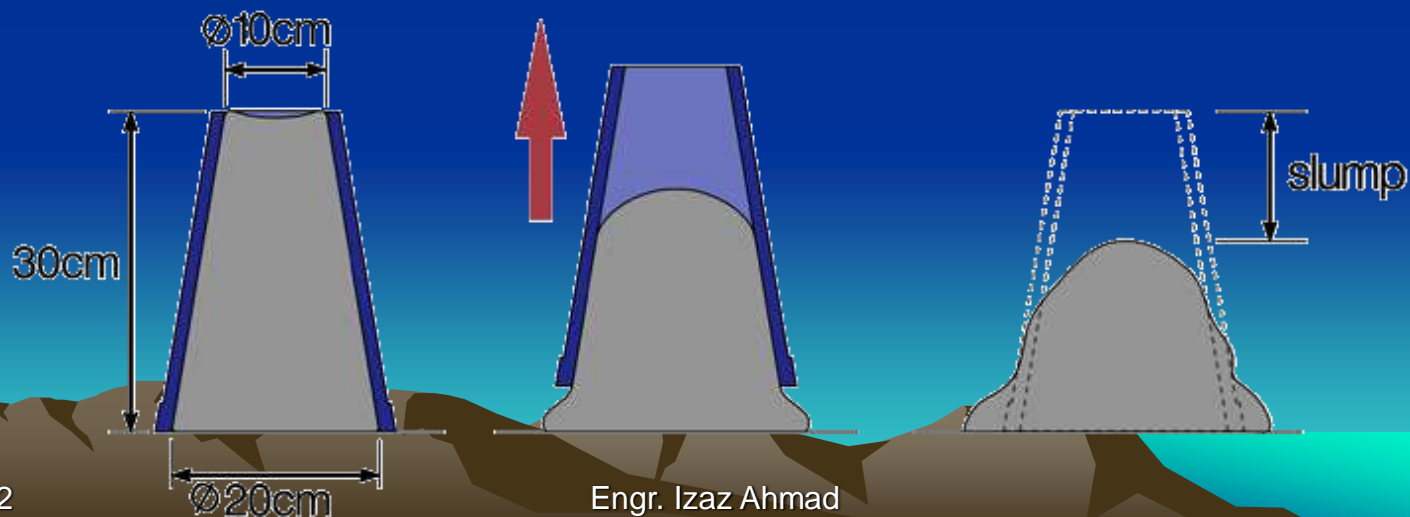

Slump Test

- **Procedure**

- The base is placed on a smooth surface and the container is filled with concrete in three layers, whose workability is to be tested .
- Each layer is temped 25 times with a standard 16 mm (5/8 in) diameter steel rod, rounded at the end.
- When the mold is completely filled with concrete, the top surface is struck off (leveled with mold top opening) by means of screening and rolling motion of the temping rod.
- The mold must be firmly held against its base during the entire operation so that it could not move due to the pouring of concrete and this can be done by means of handles or foot – rests brazed to the mold.

Slump Test

- **Procedure**

- Immediately after filling is completed and the concrete is leveled, the cone is slowly and carefully lifted vertically, an unsupported concrete will now slump.
- The decrease in the height of the center of the slumped concrete is called slump.
- The slump is measured by placing the cone just besides the slump concrete and the temping rod is placed over the cone so that it should also come over the area of slumped concrete.
- The decrease in height of concrete to that of mould is noted with scale. (usually measured to the nearest 5 mm (1/4 in)).

Slump Test

- **Precautions**

- In order to reduce the influence on slump of the variation in the surface friction, the inside of the mold and its base should be moistened at the beginning of every test, and prior to lifting of the mold the area immediately around the base of the cone should be cleaned from concrete which may have dropped accidentally.



Slump Test

- **Types Of Slump**

The slumped concrete takes various shapes, and according to the profile of slumped concrete, the slump is termed as;

- Collapse Slump
- Shear Slump
- True Slump



Collapse



Shear



True slump

Types of slump

Slump Test

- **Types Of Slump**

- **Collapse Slump**

In a collapse slump the concrete collapses completely.

Collapse slump indicates that concrete mix is too wet and the mix is regarded as harsh and lean

- **Shear Slump**

If one-half of the cone slides down an inclined plane, the slump is said to be a shear slump.

If a shear or collapse slump is achieved, a fresh sample should be taken and the test is repeated.

Shear slump indicates that the concrete lacks cohesion. It may undergo segregation and bleeding and thus is undesirable for the durability of concrete.

Slump Test

- **Types Of Slump**

- **True Slump**

True slump refers to general drop of the concrete mass evenly all around without disintegration

This is the only slump which is used in various tests.

Mixes of stiff(hard) consistence have a Zero slump, so that in the rather dry range no variation can be detected between mixes of different workability.

However , in a lean mix with a tendency to harshness, a true slump can easily change to the shear slump type or even to collapse, and widely different values of slump can be obtained in different samples from the same mix; thus, the slump test is unreliable for lean mixes.

Slump Test

- **Uses**

- The slump test is used to ensure uniformity for different batches of similar concrete under field conditions and to ascertain the effects of plasticizers on their introduction.
- This test is very useful on site as a check on the day-to-day or hour- to-hour variation in the materials being fed into the mixer. An increase in slump may mean, for instance, that the moisture content of aggregate has unexpectedly increases.
- Other cause would be a change in the grading of the aggregate, such as a deficiency of sand.
- Too high or too low a slump gives immediate warning and enables the mixer operator to remedy the situation.
- This application of slump test as well as its simplicity, is responsible for its widespread use.

Slump Test

Degree of workability	Slump (mm)	Compacting Factor	Use for which concrete is suitable
Very low	0 - 25	0.78	Very dry mixes; used in road making. Roads vibrated by power operated machines
Low	25 - 50	0.85	Low workability mixes; used for foundations with light reinforcement. Roads vibrated by hand operated Machines
Medium	50 - 100	0.92	Medium workability mixes; manually compacted flat slabs using crushed aggregates. Normal reinforced concrete manually compacted and heavily reinforced sections with vibrations
High	100 - 175	0.95	High workability concrete; for sections with congested reinforcement. Not normally suitable for vibration

Slump Test

Slump (mm)	0 - 20	20 - 40	40 - 120	120 - 200	200 - 220
Consistency	Dry	Stiff	Plastic	Wet	Sloppy

>Table : Relation between Consistency and Slump values

Slump Test

- **Difference in Standards**

The slump test is referred to in several testing and building code, with minor differences in the details of performing the test.

- **United States**

- In the United States, engineers use the ASTM standards and AASHTO specifications when referring to the concrete slump test. The American standards explicitly state that the slump cone should have a height of 12-in, a bottom diameter of 8-in and an upper diameter of 4-in. The ASTM standards also state in the procedure that when the cone is removed, it should be lifted up vertically, without any rotational movement at all. The concrete slump test is known as "Standard Test Method for Slump of Hydraulic-Cement Concrete" and carries the code (ASTM C 143) or (AASHTO T 119).

Slump Test

- **United Kingdom & Europe**

- In the United Kingdom, the Standards specify a slump cone height of 300-mm, a bottom diameter of 200-mm and a top diameter of 100-mm. The British Standards do not explicitly specify that the cone should only be lifted vertically. The slump test in the British standards was first (BS 1881-102) and is now replaced by the European Standard (BS EN 12350-2)

Concrete Workability

Concrete Workability

- **Definition**

- The property of fresh concrete which is indicated by the amount of useful internal work required to fully compact the concrete without bleeding or segregation in the finished product.
- **Workability** is one of the physical parameters of concrete which affects the strength and durability as well as the cost of labor and appearance of the finished product.

Concrete Workability

Concrete workability is the relative ease with which a fresh mix can be handled, placed, compacted, and finished without segregation or separation of the individual ingredients. Good workability is required to produce concrete that is both economical and high in quality. Fresh concrete has good workability if it can be formed, compacted, and finished to its final shape and texture with least effort and without segregation of the ingredients. Concrete with poor workability does not flow smoothly into forms or properly envelop reinforcing steel and embedded items, and it is difficult to compact and finish

Concrete Workability

- **Factors affecting workability**
 - Water content in the concrete mix
 - Amount of cement & its Properties
 - Aggregate Grading (Size Distribution)
 - Nature of Aggregate Particles (Shape, Surface Texture, Porosity etc.)
 - Temperature of the concrete mix
 - Humidity of the environment
 - Mode of compaction
 - Method of placement of concrete
 - Method of transmission of concrete

Concrete Workability

- **How To improve the workability of concrete**
 - increase water/cement ratio
 - increase size of aggregate
 - use well-rounded and smooth aggregate instead of irregular shape
 - increase the mixing time
 - use non-porous and saturated aggregate
 - with addition of air-entraining mixtures

An on site simple test for determining workability is the SLUMP TEST.

Compacting Factor Test

Introduction



Apparatus

Procedure

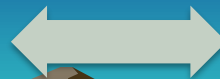

Compacting Factor Test

- **Introduction**

- These tests were developed in the UK by Glanville (1947) and it measures the degree of compaction for the standard amount of work and thus offer a direct and reasonably reliable assessment(ABILITY) of the workability Of concrete . the test require measurement of the weight of the partially and fully compacted concrete and the ratio the partially compacted weight to the fully compacted weight, which is always less than one, is known as compacted factor .
- For the normal range of concrete the compacting factor lies between 0.8 - 0.92

Compacting Factor Test

- **Apparatus**

- Trowels
- Hand Scoop (15.2 cm long)
- Rod of steel or other suitable material (1.6 cm diameter, 61 cm long rounded at one end).
- Balance.



Compacting Factor Test

- **Procedure**

- 1) Ensure the apparatus and associated equipment are clean before test and free from hardened concrete and superfluous water .
- 2) Weigh the bottom cylinder to nearest 10gm , put it back on the stand and cover it up with a pair of floats .
- 3) Gently fill the upper hopper with the sampled concrete to the level of the rim with use of a scoop .
- 4) Immediately open the trap door of the upper hopper and allow the sampled concrete to fall into the middle hopper .
- 5) Remove the floats on top of the bottom cylinder and open the trap door of the middle hopper allowing the sampled concrete to fall into the bottom cylinder .
- 6) Remove the surplus concrete above the top of the bottom cylinder by holding a float in each hand and move towards each other to cut off the concrete across the top of cylinder

Compacting Factor Test

- 7) Wipe clean the outside of cylinder of concrete and weigh to nearest 10gm .
- 8) Subtract the weight of empty cylinder from the weight of cylinder plus concrete to obtain the weight of partially compacted concrete .
- 9) Remove the concrete from the cylinder and refill with sampled concrete in layers .
- 10) Compact each layer thoroughly with the standard Compacting Bar to achieve full compaction .
- 11) Float off the surplus concrete to top of cylinder and wipe it clean .
- 12) Weigh the cylinder to nearest 10gm and subtract the weight of empty cylinder from the weight of cylinder plus concrete to obtain the weight of fully compacted concrete .

Compacting Factor Test

The Compacting Factor (CF) = $\frac{\text{weight of partially compacted concrete}}{\text{weight of fully compacted concrete}}$

Workability	Slump (mm)	C.F	Uses
Very Low	0 - 25	0.78	Roads - Pavements
Low	25 - 50	0.85	Foundations Concrete
Medium	25 - 100	0.92	Reinforced Concrete
High	100 - 175	0.95	Reinforced Concrete (High Reinforcement)

Concrete Segregation

Concrete Segregation

Segregation can be defined as separation of the constituents of a heterogeneous mixture so that their distribution is no longer uniform. *The differences in the size particles* of the concrete constituents are the primary cause of segregation, but its extent *can be controlled by the choice of suitable grading* and by care handling. Concrete mixes should not segregate (i.e it ought to be cohesive; the absence of segregation is essential if full compaction is to be achieved.

Concrete Segregation

There are two forms of segregation:

1- The coarser particles tend to separate out since they travel further along a slope or settle more than finer particles. It occurs when the mix is too dry

2- It occurs in wet mixes through separation of cement paste from the mix.

Concrete Segregation

The actual extent of segregation depends on **the method of handling and placing of concrete**. If concrete does not have far to travel and is transferred directly from the skip or the wheelbarrow to the final position in the formwork, the danger of segregation is small. On the other hand, dropping concrete from a considerable height, particularly with changes of direction, and discharging against an obstacle(difficulty), all encourage segregation. Therefore, such circumstances should be under control. With correct method of handling, transporting, and placing, the likelihood of segregation can be greatly reduced. **Air entraining admixtures can be used to control segregation.**

Concrete Segregation

Following are the factors that contribute to increased segregation

1. Larger maximum particle size (over 25 mm) and proportion of the large particles.
2. A high specific gravity of the coarse aggregate compared to that of the fine aggregate.
3. A decreased amount of fines (sand or cement).
4. Changes in the particle shape away from smooth, well-rounded particles to odd-shaped, rough particles.
5. Mixes that are either too wet or too dry.

Concrete Segregation

- Segregation makes the concrete
 - Weaker,
 - Less durable,
 - And will leave a poor surface finish



Concrete Segregation

- **Basic types of segregation**

- Coarse segregation : Occurs when gradation is shifted to include too much coarse aggregate and not enough fine aggregate. Coarse segregation is characterized by low asphalt content, low density, high air voids, rough surface texture, and accelerated rutting and fatigue failure (Williams et. al., 1996b). Typically, coarse segregation is considered the most prevalent and damaging type of segregation; thus segregation research has typically focused on coarse segregation. The term “segregation” by itself is usually taken to mean “coarse segregation.”
- Fine segregation : Occurs when gradation is shifted to include too much fine aggregate and not enough coarse aggregate. High asphalt content, low density, smooth surface texture, accelerated rutting, and better fatigue performance characterize fine segregation (Williams, Duncan and White, 1996).

Concrete Segregation

• To Avoid Segregation

- Check the concrete is not 'too wet' or 'too dry'.
- Make sure the concrete is properly mixed. It is important that the concrete is mixed at the correct speed in a transit mixer for at least two minutes immediately prior to discharge.
- The concrete should be placed as soon as possible.
- When transporting the mix, load carefully.
- Always pour new concrete into the face of concrete already in place.
- When compacting with a poker vibrator be sure to use it carefully



Concrete Segregation

- **To Avoid Segregation**

- If placing concrete straight from a truck, pour vertically and never let the concrete fall more than one-and-a-half meters.



Concrete Segregation



Concrete Bleeding

Concrete Bleeding

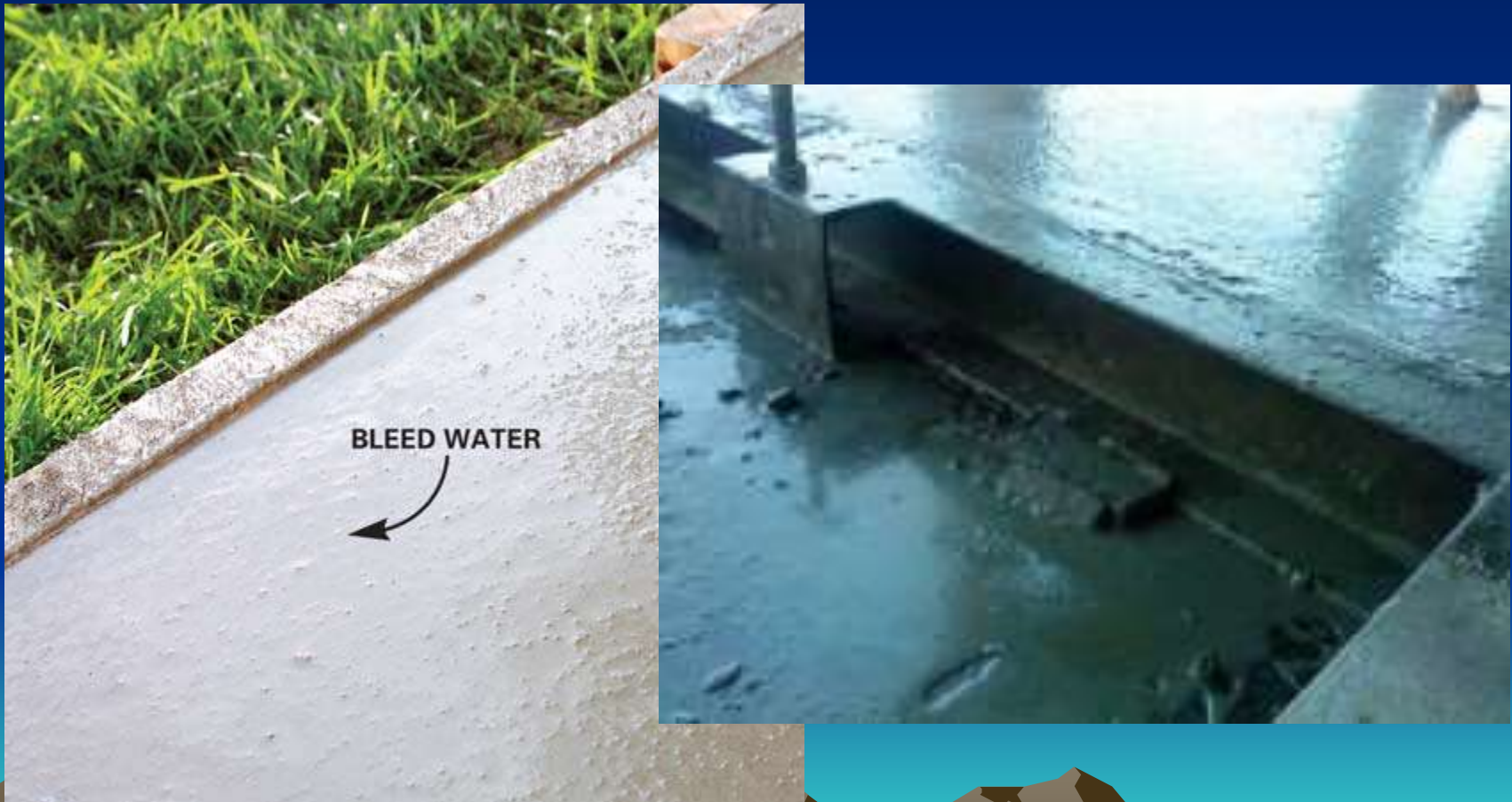

Concrete Bleeding

Introduction

Bleeding, known also as water gain, is a form of segregation in which some of the water in the mix tends to rise to the surface of freshly placed concrete. This is caused by the inability of the solid constituents of the mix to hold all of the mixing water when they settle downwards. Bleeding can be expressed quantitatively as the total settlement (reduction in height) per unit height of concrete, and the bleeding capacity as well as the rate of bleeding can be determined experimentally using the test of ASTM C 232-04. When the cement paste has stiffened sufficiently, bleeding of concrete ceases.

Concrete Bleeding

This happens when there is excessive quantity of water in the mix or due to excessive compaction. Bleeding causes the formation of pores and renders the concrete weak. **Bleeding can be avoided by suitably controlling the quantity of water in the concrete and using finer grading of aggregates.**

Concrete Bleeding

- **Bleeding Process**

- Almost all freshly placed concrete bleeds. As aggregate and cement particles settle, they force excess mixing water upward. The process continues until settlement stops, either because of solids bridging or because the concrete has set.
- The total amount of bleeding or settlement depends on mix properties, primarily water content and amount of fines (cement, fly ash, fine sand). **Increasing water content increases bleeding, and increasing the amount of fines reduces bleeding.** Amount of bleeding is also proportional to the depth of concrete placed. More bleed water rises in deep sections than in thin ones.

Concrete Bleeding

- Bleeding usually occurs gradually by uniform seepage over the whole surface, but sometimes vertical channels form. Water flows fast enough in these channels to carry fine particles of cement and sand, leaving "wormholes" in the interior or sand streaks at the form face. Channels are more likely to form when concrete bleeds excessively.
- Channels that reach the surface are open paths for deicing solutions to penetrate the concrete. This leads to freezing and thawing damage and rebar corrosion.

Concrete Bleeding

Effects Of Excessive bleeding

- As a result of bleeding, the top of every lift (layer of concrete placed) may become too wet, and, if the water is trapped by superimposed concrete, a porous and weak layer of non-durable concrete will result.
- If the bleeding water is remixed during the finishing of the top surface, a weak wearing surface will be formed. This can be avoided by delaying the finishing operations until the bleeding water has evaporated, and also by the use of wood floats and by avoidance of over-working of the surface.

Concrete Bleeding

- On the other hand, if evaporation of water from the surface of the concrete is faster than the bleeding rate, plastic shrinkage cracking may result.
- In addition to accumulating at the upper surface of the concrete, some of the rising water becomes trapped on the underside of large aggregate particles or of reinforcement, thus creating zones of poor bond. This water leaves behind voids and, since all these voids are oriented in the same direction, the permeability of the concrete in a horizontal plane may be increased.

Concrete Bleeding

- If the rising water carries with it a considerable amount of the finer cement particles, a layer of laitance will be formed. If this is at the top of a slab, a porous surface will result with a permanently “dusty” surface. At the top of a lift, a plane of weakness would form and the bond with the next lift would be inadequate. For this reason, laitance should always be removed by brushing and washing.
- Although dependent on the water content of the mix, the tendency to bleeding depends largely on the properties of the cement. Bleeding is lower with finer cements and is also affected by certain chemical factors: there is less bleeding when the cement has a high alkali content, a high C3A content, or when calcium chloride is added.

Concrete Bleeding

Methods of reducing segregation and bleed and their effects

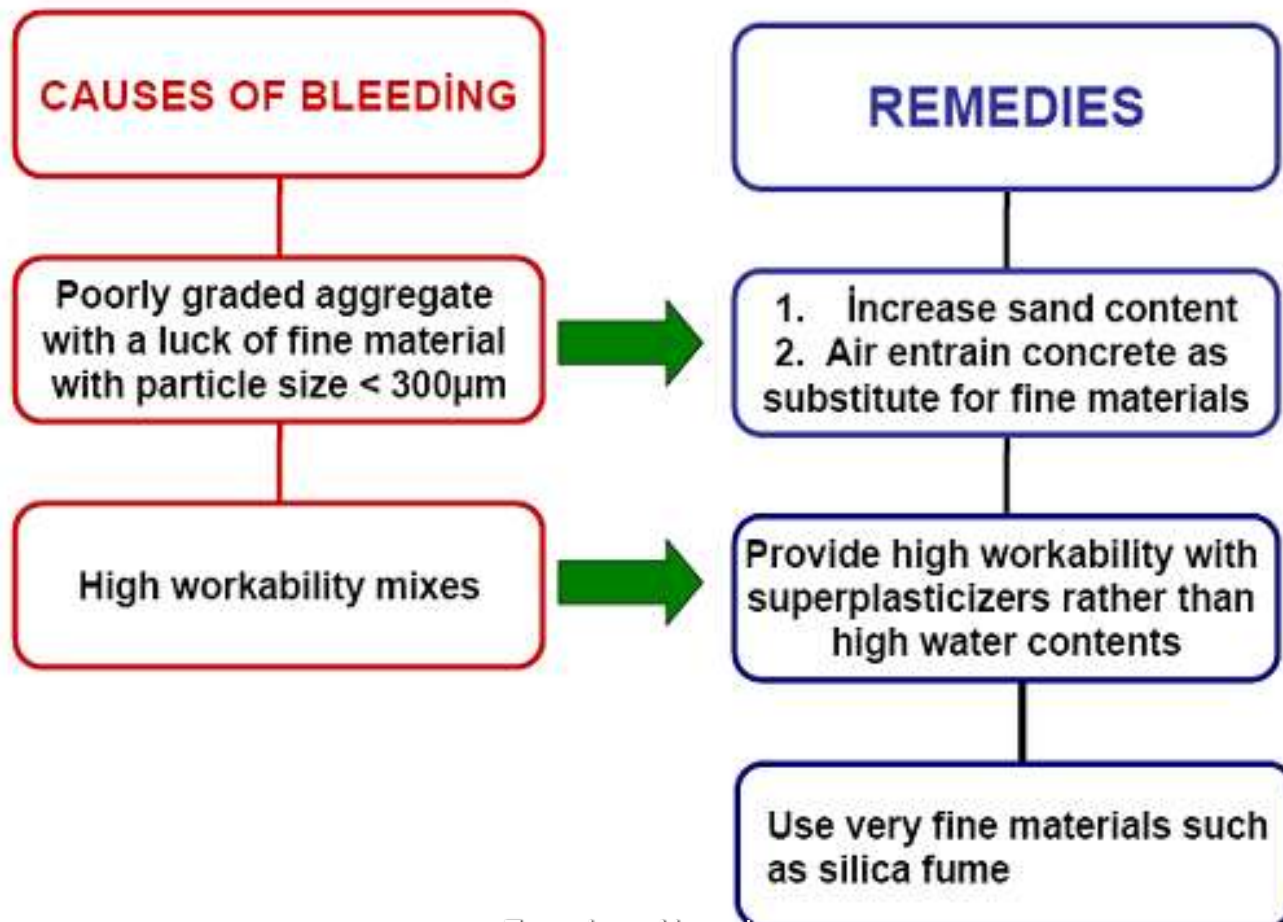

Helping material

Concrete Batching

In general batching is the process of measuring and combining the ingredients of concrete (cement, water, sand, aggregates)...as per the mix design. The last part is important, if you are an Engineer then you will have to do a concrete mix design to know the quantity required for each element of concrete...so basically, you will say “for C-30 concrete member we need 50kg of cement per meter cube of the member or 20kg of aggregate per meter cube...etc this is the mix design.

Now the batching(measuring and mixing) could be done in two ways like you said. Weight batching is the professional one, which is always recommended. Basically, you measure each quantity by mass (using a large weigh equipment) and batch the components in a controlled environment

Special Concretes

UNIT-5

General

- Special concretes are the concrete prepared for specific purpose like **light weight, high density, fire protection, radiation shielding** etc. concrete is a versatile material possessing good compressive strength. But it suffers from many drawbacks like **low tensile strength, permeability to liquids, corrosion of reinforcement, susceptibility to chemical attack and low durability.**
- Modification have been made from time to time to overcome the deficiencies of cement concrete. The recent developments in the material and construction technology have led to significant changes resulting in improved performance, wider and more economical use.
- Research work is going on in various concrete research laboratories to get improvement in the performance of concrete.

General

- Attempts are being made for improvements in the following areas.
- Improvement in **mechanical properties** like **compressive strength, tensile strength, impact resistance**.
- Improvement in **durability** in terms of increased **chemical** and **freezing resistances**.
- Improvements in **impermeability, thermal insulation, abrasion, skid resistance** etc.

Different Types of Special Concrete

are:

- Light Weight Concrete
- High Density Concrete
- Plum Concrete
- No Fines Concrete
- Aerated Concrete
- Fiber Reinforced Concrete (FRC)
- Polymer Concrete
- Ferro cement
- High Strength Concrete
- High Performance Concrete

Difference Between Ordinary and Special Concrete

Ordinary Concrete	Special Concrete
Ordinary concrete is used for normal works like building, bridges, road etc.	This type of concrete is used for special type of structures like nuclear reactor, buildings with acoustic treatment, air conditioned buildings etc.
Ingredients of ordinary concrete are cement, sand, aggregate and water.	In case of light weight aggregate concrete, light weight aggregates are used. In polymer concrete, polymer binder is used instead of water.
Construction is carried out by conventional method.	Concreting is done by special techniques
Properties of Concrete like density, strength etc. are of normal range.	Properties of concrete like density strength are of higher range. For example, density of light weight concrete is about 500 to 2000 kg/m ³ and that of heavy weight concrete is about 3000 to 5000 kg.m ³
It is economical	It is costly

Light Weight Concrete

(May 2011)

- The **density** of conventional concrete is in order of **2200 to 2600 kg/m³**. This heavy self weight will make it uneconomical structural material. The dead weight of the structure made up of this concrete is large compared to the imposed load to be carried. A small reduction in dead weight for structural members like slab, beam and column in high-rise buildings, results in considerable saving in money and manpower.
- Attempts have been made in the past to reduce the self weight of the concrete to increase the efficiency of concrete as a structural material. **The light weight concrete with density in the range of 300 to 1900 kg/m³ have been successfully developed.**

Light Weight Concrete

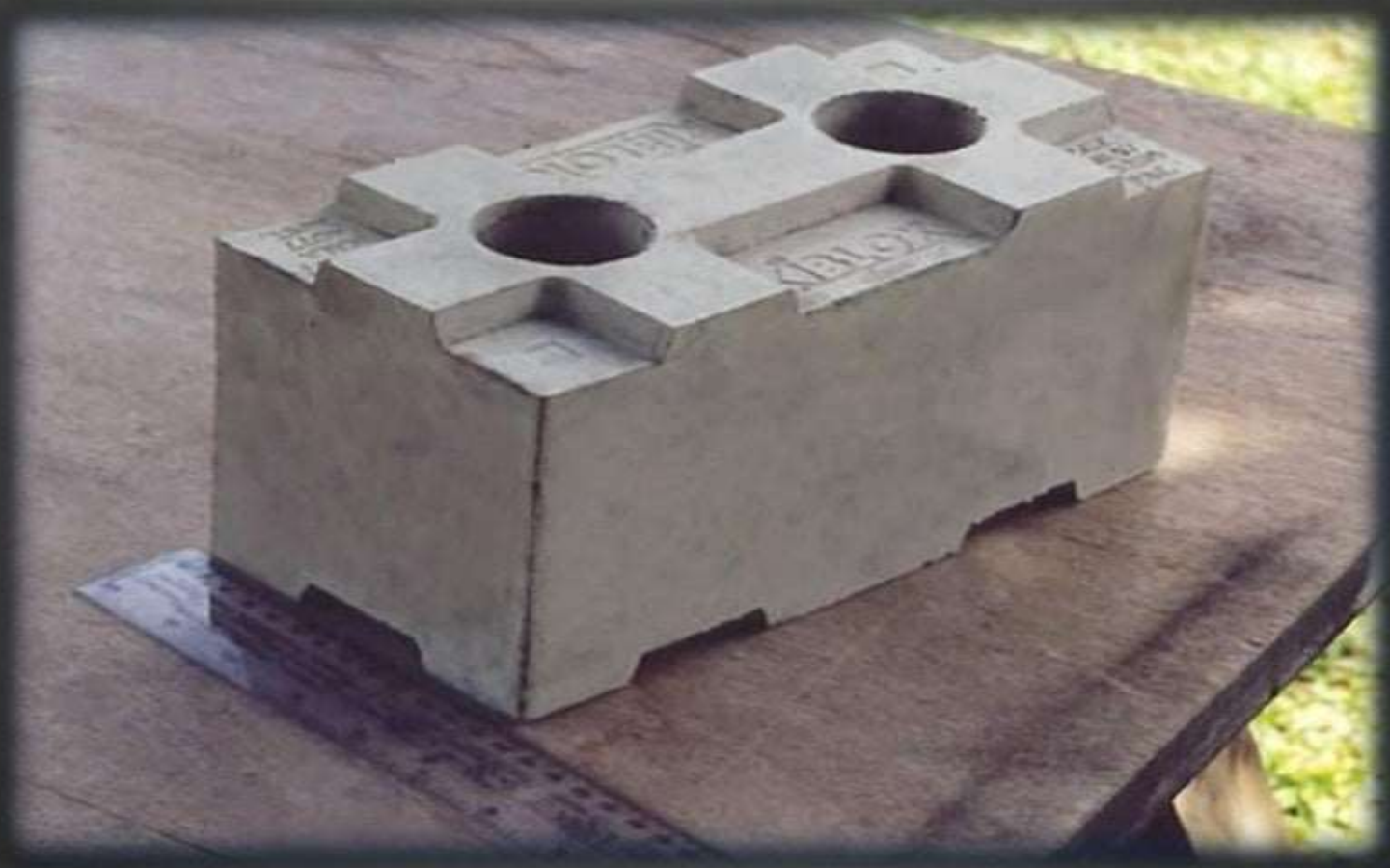

The Light Weight Concrete Offers The Following **Advantage:**

- Reduction of **Dead Load**
- **Smaller section** of structural members can be adopted.
- **Lower haulage and handling costs.**
- Increase in the progress of work.
- Reduction of **foundation costs**, particularly in the case of **weak soil and tall structures.**
- **Light weight concrete has a lower thermal conductivity.** In case of buildings where air conditioning is to be installed, **the use of light weight concrete will result in better thermal comforts and lower power consumption.**

The Light Weight Concrete Offers The Following Advantage:

- The use of light weight concrete gives an outlet for industrial wastes such as fly ash, clinkers, slag etc. which otherwise create problem for disposal.
- It offers great fire resistance.
- Light weight concrete gives overall economy.
- The lower modulus of elasticity and adequate ductility of light weight concrete may be advantageous in the seismic design of structures.

The Light Weight Concrete Is Achieved By Three Different Ways:

- By replacing the normal mineral aggregate, by cellular porous or light weight aggregate.
- By introducing air bubble in mortar this is known as ‘ aerated concrete’.
- By omitting sand fraction from the aggregate
This is known as ‘ no fines concrete’.

Light Weight Concrete



Light Weight Aggregate Concrete

Light Weight Aggregates



Natural light weight
aggregate

Pumice

Scoria

Rice Husk

Diatomite

Volcanic tuff

Foamed lava

Artificial light weight
aggregate

Sintered fly ash

Foamed slag

Bloated Clay

Artificial Cinders

Expanded clay, slate, shale

Coke breeze

Expanded perlite

Exfoliated vermiculite

Light Weight Aggregates

- **Natural light weight aggregate:**
- **Pumice:** These are rocks of volcanic origin. They are light coloured or nearly white and has a fairly even texture of interconnected voids. Its bulk density is $500 - 800 \text{ kg/ m}^3$.
- **Scoria:** Scoria is light weight aggregate of volcanic origin, They are dark in colour It is slightly weaker than pumice.
- **Rice Husk:** Use of rice husk or groundnut husk has been reported as light weight aggregate.
- **Saw dust:** Saw dust is used as light weight aggregate in the flooring and in the manufacture of precast elements. But the presence of carbohydrates in the wood, adversely affect the setting and hardening of Portland cement.
- **Diatomite:** It is derived from the remains of microscopic aquatic plants called diatoms. It is also used as a pozzolanic material.

Natural light weight aggregate:

Pumice



Scoria



Rice Husk



Saw
Dust



Diatomite



Light Weight Aggregates

- **Artificial Light Weight Aggregates:**
- **Sintered flash (Pulverized fuel ash):**
The fly ash collected from modern thermal power plants burning pulverized fuel, is mixed with water and coal slurry in screw mixers and then fed on to rotating pans, known as pelletizers, to form spherical pellets. The pellets are then fed on to a sinter strand at a temperature of 1000 °C to 1200 °C. Due to sintering the fly ash particles coagulate to form hard brick like spherical particles. The produces material is screened and graded. In UK it is sold by the trade name 'Lytag'.



Artificial Light Weight Aggregates

- **Foamed Slag:** Foamed slag is a by product produced in the manufacture of pig iron. It is a porous, honeycombed material which resembles pumice.
- **Bloated Clay:** When special grade of clay and shales are heated to the point of incipient fusion, there will be expansion due to formation of gas within the mass. The expansion is known as bloating and the product so formed is used as light weight aggregate.



Artificial Light Weight Aggregates

- **Exfoliated vermiculite:** The raw vermiculite material resembles mica in appearance and consists of thin flat flakes containing microscopic particles of water. On heating with certain percentage of water it expands by delamination in the same way as that of slate or shale. This type of expansion is known as exfoliation. The concrete made with vermiculate as aggregate will have very low density and very low strength.
- **Ciders, clinkers, breeze:** The partly fused or sintered particles arising from the combustion of coal, is termed as cinder or clinker or breeze. Cinder aggregate undergo high drying shrinkage and moisture movement. These are used for making building blocks for partition walls, for making screening over flat roofs and for plastering purposes.

Artificial Light Weight Aggregates



Exfoliated Vermiculite



Clinkers

Aerated Concrete

- The aerated concrete is made by introducing air or gas bubbles into the plastic cement mortar mix to produce a material with a cellular structure, somewhat similar to sponge rubber . It is also known as ‘ Gas Concrete’ or ‘Foam Concrete’ or ‘ Cellular Concrete’. It is a mixture of water, cement and finely crushed sand.
- The aerated concrete is different from air entrained concretes, through in both cases air is introduced into the material. Air entrained concrete contains a much lower proportion of air and is in fact a heavy concrete whereas the amount of aeration is more in cellular concrete and it is weight concrete.
- The cellular concrete may or may not contain coarse aggregates. The densities generally range from 300 kg/ m^3 to 1000 kg / m^3 . lower density grades are used for insulation purposes, medium density grades are used for the manufacture of prefabricated structural members.

Application

- Different application of aerated concrete are as follows:
- As **load bearing masonry** walls using cellular concrete blocks.
- As **partition walls** in residential, institutional and industrial buildings.
- As precast composite wall or floor panels
- As a filler wall in the form of precast reinforced wall panels in high-rise building
- As **precast floor** and roof panels in all types of buildings.
- As **insulation cladding to exterior walls** of all types of buildings.

Aerated Concrete



No Fines Concrete

- ‘No fines concrete’ is obtained by omitting fine aggregate fraction (below 12 mm) from the conventional concrete. It consists of cement, coarse aggregates and water only. Cement Content is correspondingly increased. Very often only single sized coarse aggregate, of size passing through 20 mm and retained on 10 mm is used. By using single sized aggregate, voids can be increased. The actual void content may vary between 30 to 40 percent depending upon the degree of consolidation of concrete.
- No fines concrete is generally made with **the aggregate/ cement ratio 6:1 to 10:1**. The **water/ cement ratio for satisfactory consistency will vary between 0.38 to 0.50**. The strength of no fines concrete is dependent on the **water/ cement ratio, aggregate/ cement ratio and unit weight of concrete**.

No Fines Concrete

- When conventional aggregate are used, no-fines concrete show a **density of about 1600 to 2000 kg/ m³**. but by using light weight aggregate, the density may reduced to about 350 kg/m³. Through the strength of no fines concrete is lower than ordinary concrete, the strength are sufficient for use in structural members and load bearing wall in normal buildings up to 3 stories high. Strengths **of the order of 15 N/mm²** have been attained with **no fines concrete**. The bond strength of no-fines concrete is very low and therefore, reinforcement is not used in no-fines concrete. However, if reinforcement is required to be used in no fines concrete, it is advisable to smear the reinforcement with cement paste to improve the bond strength and to protect it from rusting.

No Fines Concrete



High Density Concrete

- High density concrete is also known as ‘**heavy weight concrete**’. High density concrete is produced by replacing the ordinary aggregate by a material of very much higher specific gravity, usually over 4.0, compared with the specific gravity of ordinary aggregate of about 2.6. One of the more common natural aggregate is **barium sulphate**. It has a **specific gravity of 4.1**, and occurs as a natural rock with a purity of about 95%. Barytes behaves rather like ordinary crushed aggregate and does not present any special problems as far as proportioning of mixes is concerned. The aggregate tends to break up and dust so that care must be taken in handling and processing and over mixing should be avoided.
- Another type of natural **heavy weight aggregate is iron: magnetite, limonite, hematite and goethite have been used**. By using iron ore aggregate concrete concrete **with densities of between 3000 to 3900 kg/ m³** can be made.

High Density Concrete

- The high density concrete is used in the construction of radiation shielding i.e. in nuclear power plants. The questions of shielding resolves into protection against X-rays, Gamma rays and neutrons. The biological hazards of radiation arise from the fact that the radiation interacts with human tissues, losing some of their energy in the process. This energy loss is sufficient to ionize atoms in the cell, upsetting the delicate chemical balance and causing the death of the cells. If enough cells are affected the organisms dies.
- High density concrete is also suitable for preparing counter-balance weights for lifting bridges and ballast blocks for ships, where the high density concrete reduces the volume of concrete required to produce the same dead weight, leading to economy.

High Density Concrete

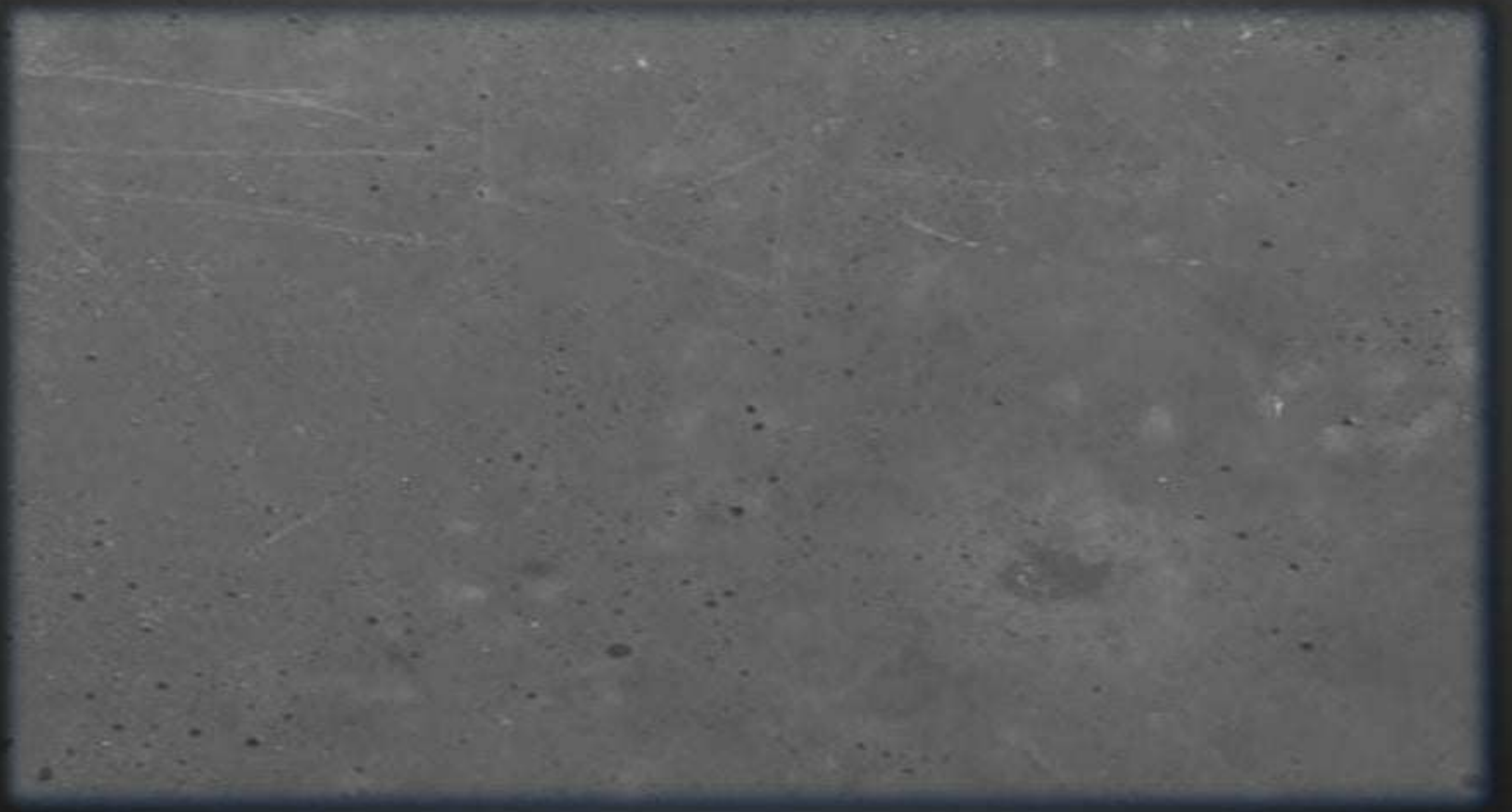

Mass Concrete

- The concrete placed in massive structures like dams, canal locks, bridge, piers etc. can be termed mass concrete. This concrete is placed in large open forms. The mix is relatively harsh and dry and requires power vibrators of the immersion type for compaction.
- Because of the large mass of the concrete, the heat of hydration of cement may lead to a considerable rise of temperature in the concrete thus resulting in extensive and serious shrinkage cracks. These shrinkage cracks can be prevented by using low heat cements and continuous curing. Placing the concrete in small lifts and allowing several days before the placement of the next lift of concrete can help in the dissipation of heat. The concreting can be done preferable in winter season, such that the peak temperature in concrete can be lowered or as an alternative the aggregate may be cooled and then used. Circulation of cold water through pipes buried in the concrete mass may prove useful.
- The mass concrete develops high early age strength but the later age strength is lower than that of continuously cured concrete at normal temperature. There is negligible volume change in the case of mass concrete during setting and hardening but large creep may occur at later ages.

Mass Concrete



Plum Concrete

- The original idea of the use of aggregate as an inert filler can be extended to the **inclusion of large stones upto 300 mm size in a normal concrete**; thus the apparent yield of concrete for a given amount of cement is increased. The resulting concrete is called '**Plum Concrete**' or '**Cyclopean Concrete**'.
- **These large stones are called 'plums' and used in a large concrete mass.** The volume of plums should not exceed 20 to 30 % of the total volume of the finished concrete and they have to be well dispersed throughout the mass. This is achieved by placing a layer of normal concrete, then spreading the plums, followed by another layer of concrete and so on. Care must be taken to ensure that no air is trapped underneath the stones.
- The plums must have no adhering coating. Otherwise, discontinuities between the plums and the concrete may induce cracking and adversely affect permeability.

Plum Concrete



Fiber Reinforced Concrete (FRC)

- In conventional concrete, micro-cracks develop even before loading because of drying shrinkage and other causes of volume change. **When the structure is loaded, the micro cracks open up and propagate.** The development of such **micro-cracks** is the main reason of **inelastic deformation in concrete.**
- **The weakness can be removed by inclusion of small, closely spaced and uniformly dispersed fibers in concrete.** The addition of fibers in concrete **substantially improve its static and dynamic properties.** These fibers offer increased resistance to crack growth, through a crack arresting mechanism and improve tensile strength and ductility of concrete.

Fiber Reinforced Concrete (FRC)

- Fiber reinforced concrete (FRC) can be defined as a composite material consisting of concrete and discontinuous, discrete, uniform dispersed fine fibers. The continuous meshes, woven fabrics and long wires or rods are not considered to be discrete fibers.
- The inclusion of fibers in concrete and shotcrete generally improves material properties like ductility, flexural strength, toughness impact resistance and fatigue strength. There is little improvement in compressive strength. The type and amount of improvement in compressive strength. The type and amount of improvement is dependent upon the fibre type, size, strength and configuration and amount of fibre

Fiber Reinforced Concrete (FRC)



Types of fibers

- Fiber is a small discrete reinforcing material produced from steel, polypropylene, nylon, glass, asbestos, coir or carbon in various shape and size. They can be circular or flat.
- **Steel fibers:** Steel fibre is one of the most commonly used fibre. They are generally round. The diameter may vary from 0.25 mm to 0.75 mm. The steel fibre is likely to get rusted and lose some of its strength. Use of steel fibre makes significant improvements in flexural impact and fatigue strength of concrete.
- Steel fibers have been extensively used in overlays or roads, pavements, air fields, bridge decks, thin shells and floorings subjected to wear and tear and chemical attack.

Steel Fibers



Types of fibers

- **Glass Fibers:**

- These are produced in three basic forms:
 - (a) Rovings
 - (b) Strands
 - (c) Woven or chopped strand mats.
- Major problems in their use are breakage of fibre and the surface degradation of glass by high alkalinity of the hydrated cement paste. However, alkali resistant glass fibre have been developed now. Glass fibre reinforced concrete (GFRC) is mostly used for decorative application rather than structural purposes.
- With the addition of just 5 % glass fibers, an improvement in the impact strength of up to 1500 % can be obtained as compared to plain concrete. With the addition of 2 % fibers the flexural strength is almost doubled.

Glass Fibers

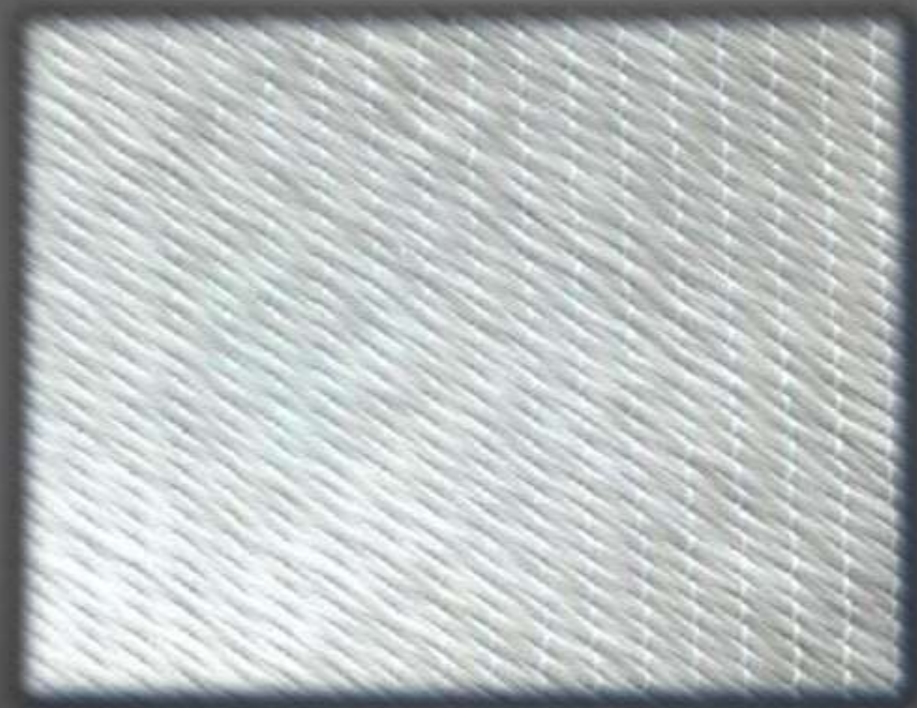

Types of fibers

- **Plastic fibers:** Fibers such as polypropylene, nylon, acrylic, aramid and polyethylene have high tensile strength thus inhibiting reinforcing effect. Polypropylene and nylon fibers are found to be suitable to increase the impact strength. Their addition to concrete has shown better distribute cracking and reduced crack size.



Types of fibers

- **Carbon Fibers:** Carbon fibers possess high tensile strength and high young's modulus. The use of carbon fibre in concrete is promising but is costly and availability of carbon fibre in India is limited.
- **Asbestos fibers:**
- Asbestos is a mineral fibre and has proved to be most successful fibre, which can be mixed with OPC. The maximum length of asbestos fibre is 10 mm but generally fibers are shorter than this. The composite has high flexural strength.

Carbon Fiber

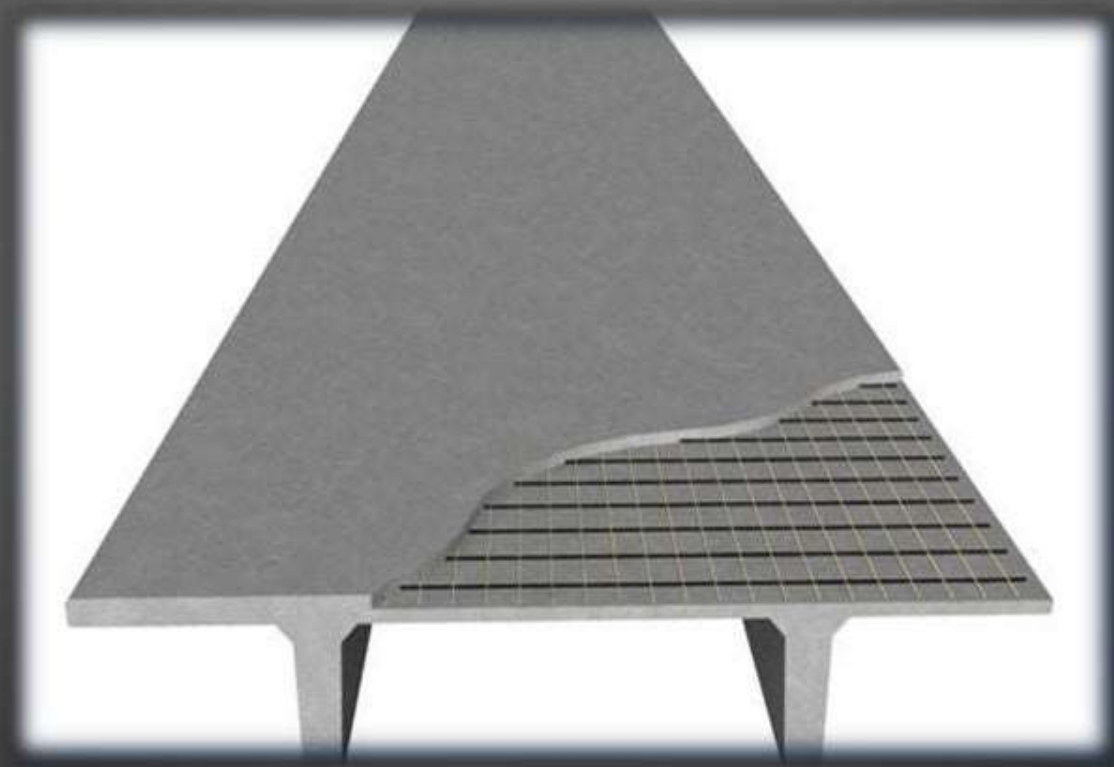

Asbestos fibers



Factors Affecting Properties Of Fiber Reinforced Concrete

- The important factors affecting properties of FRC are as follows:
- Volume of fibers
- Aspect ratio of fibers
- Orientation of fibers
- Size of coarse aggregate
- Workability and compaction of Concrete
- Mixing

Polymer Concrete

- Concrete containing polymers can be classified into three categories, namely:
- (a) Polymer- Impregnated Concrete (PIC)
- (b) Polymer Portland Cement Concrete (PPCC)
- (c) Polymer Concrete (PC)

Polymer-Impregnated Concrete (PIC)

- **Polymer-** Impregnated Concrete is produced by impregnating or infiltrating a hardened Portland cement concrete with a monomer and subsequently polymerizing the monomer in situ. It is one of the widely used polymer composite.
- The partial or surface impregnation improves durability and chemical resistance while total or in-depth impregnation improves structural properties of concrete.
- The monomer used for impregnation are:
 - Methyl methacrylate (MMA)
 - Styrene
 - Acrylonitrile
 - T-butyl styrene
 - Epoxy

Polymer-Impregnated Concrete (PIC)



Polymer Portland Cement Concrete (PPCC)

- Polymer Portland cement concrete is a conventional Portland cement concrete which is usually made by replacing a part of the mixing water with a latex (Polymer emulsion). Earlier latexes were based on polyvinyl acetate or polyvinylidene chloride, but these are seldom used now because of the risk of corrosion of steel in concrete in the latter case and low wet strengths in the former.
- Both elastomeric and glassy polymers have been employed in lattices.

Polymer Portland Cement Concrete (PPCC)

- The latex systems for modifying cement concrete are now available in India. The latex generally contains about 50 % by weight of spherical and very small polymer particles held in suspension in water by surface active agents. The presence of surface active agents in the latex tends to incorporate large amounts of entrained air in concrete, therefore, air detrainning agents are usually added to commercial latexes. Since 10 to 25 percent polymer by weight of cement is used in typical latex modified concrete formulations, the addition of latex provides a large quantity of the needed mixing water in concrete. Therefore, latex modified concrete is made with as low an addition of extra mixing water as possible.

Polymer Portland Cement Concrete (PPCC)



Polymer Concrete (PC)

(Resin Concrete)

- Polymer Concrete (PC) is a mixture of aggregates with a polymer as a sole binder. There is no other bonding material present, i.e. Portland cement is not used.
- It is manufactured in a manner similar to that of cement concrete. Monomers or Pre-polymers are added to the graded aggregate and the mixture is thoroughly mixed by hand or machine. The thoroughly mixed polymer concrete material is cast in moulds of woods, steel or aluminium, etc.
- To minimize the amount of the expensive binder, it is very important to achieve the maximum possible dry packed density of the aggregates. For Ex, using two different size fractions of 20 mm maximum coarse aggregate and five different size fractions of sand, higher densities can be achieved.

Polymer Concrete (PC)

(Resin Concrete)

- The polymer concrete material cast in the mould is then polymerized either at room temperature or at an elevated temperature. The polymer phase binds the aggregate to give a strong composite. The polymer concrete material cast in the mould is then polymerized either at room temperature or at an elevated temperature. The polymer phase binds the aggregate to give a strong composite. Polymerization can be achieved by any of the following methods.
 - Thermal-catalytic reaction
 - Catalyst-promoter reaction
 - Radiation

Polymer Concrete (PC) (Resin Concrete)



Ferro Cement

- Ferro cement is a relatively new material consisting of wire meshes and cement mortar. It consists of closely spaced wire meshes which are impregnated with rich cement mortar mix. While the mortar provides the mass, the wire mesh imparts tensile strength and ductility to the material. The Ferro cement possess high resistance against cracking, high fatigue resistance higher toughness and higher impermeability.

Ferro Cement

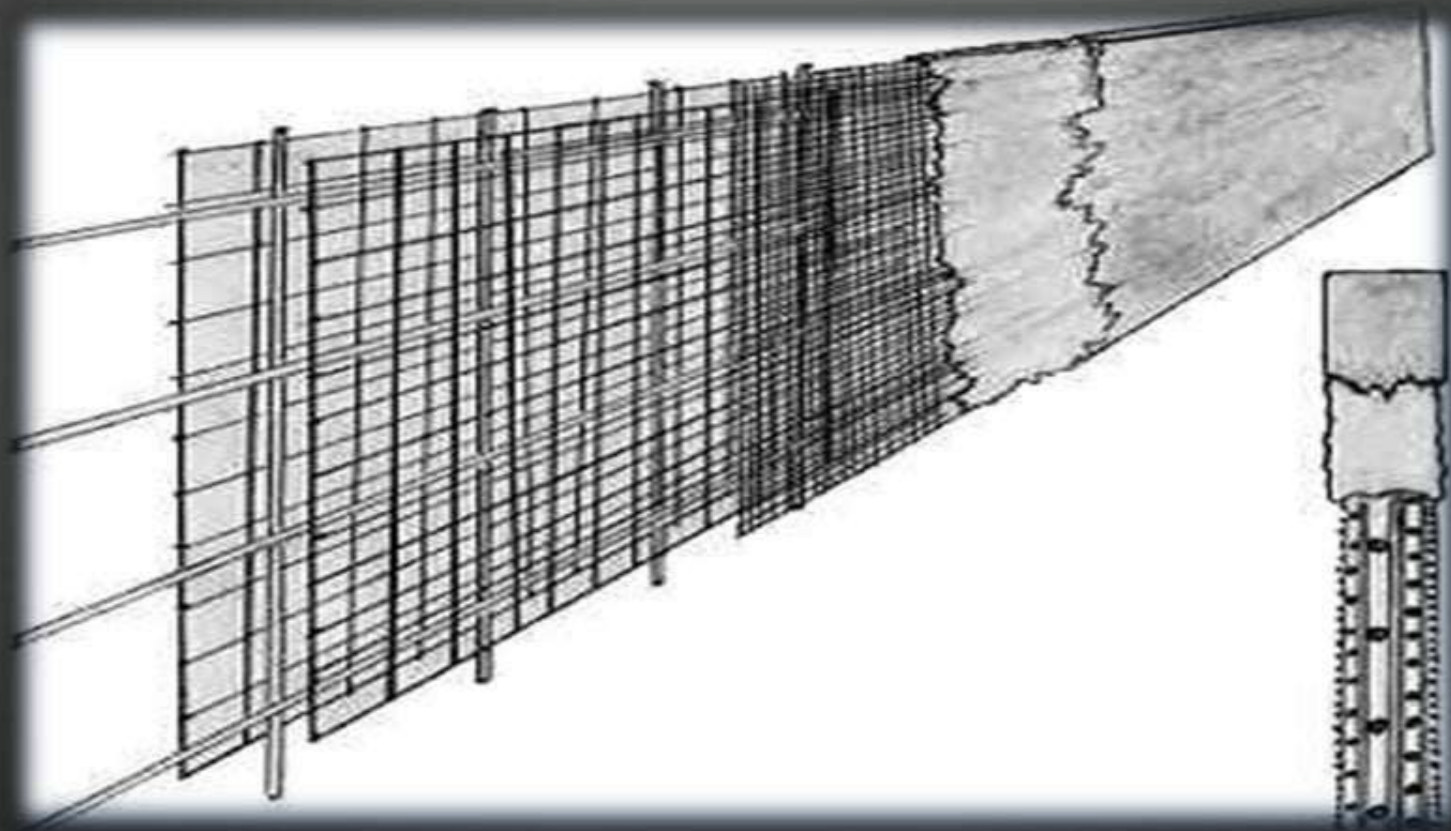

Materials used for ferrocement:

- **Cement mortar matrix:**
- Normally, Portland cement and fine aggregate matrix is used in ferrocement. The matrix constitutes of about 95 % of the ferrocement and governs the behavior of the final product. The cement mortar is of the cement-sand ratio 1:2 to 1:3 with W/C ratio of 0.4 to 0.45. the ferrocement elements are usually of the order of 20 to 30 mm in thickness with 2 to 3 mm external cover to the reinforcement.
- The fine aggregate conforming to grading zone-II and zone –III with particles greater than 2.36 mm and smaller than 150 μm removed are suitable for ferrocement. The use of fine sand is not recommended in ferrocement.

Materials used for ferrocement

- Plasticizers and other admixtures may be added to improve workability, increase in durability, reduction in permeability and increase in strength. Pozzolanas such as fly ash may be added upto 30 % as cement replacement to increase the durability. Reduction impermeability and increase in strength. Pozzolanas such as fly ash may be added upto 30 % as cement replacement to increase the durability.
- **(2) Reinforcement:**
- Two types of reinforcements, namely ‘skeleton steel’ and ‘wire mesh’ are used in ferrocement.

Materials used for ferrocement

- **Skeleton steel:** The skeleton steel comprises relatively large-diameter (about 3 to 8 mm) bars spaced at 75 mm to 100 mm. It may be tied-reinforcement or welded wire fabric. The skeleton steel frame is made conforming to the geometry and shape of structure and is used for holding the wire meshes in position and shape of the structure.
- **Wire mesh:** The wire mesh consisting of galvanized wire of 0.5 to 1.5 mm diameter and 6 to 20 mm centre to centre spacing is used. The wire meshes are formed by welding, twisting or weaving. The welded wire mesh may have either square or hexagonal openings. The mesh with square openings is more efficient than the hexagonal wire mesh but it is costly. Generally, the square woven meshes consisting of 1.0 or 1.5 mm diameter wire spaced at 12 mm are preferable.

Skeleton steel

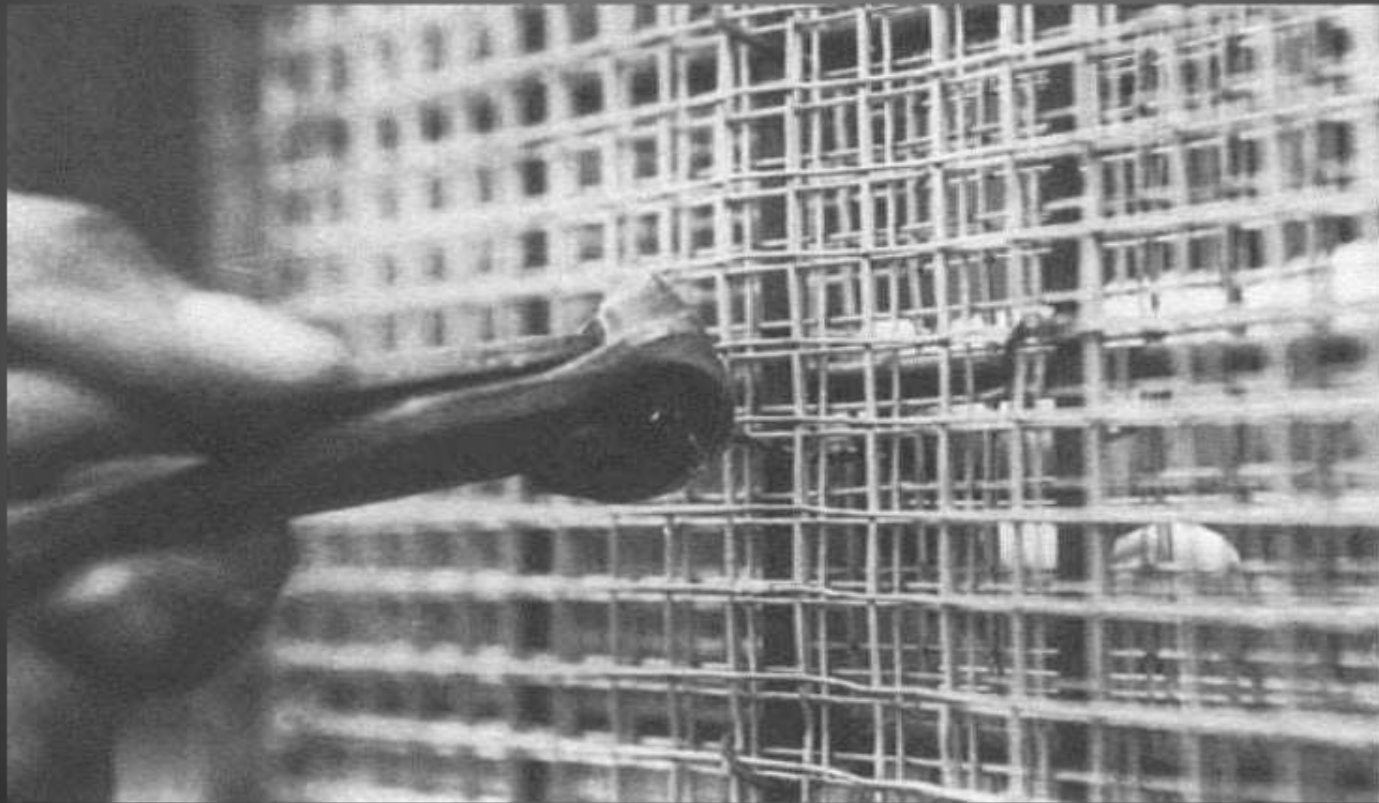

Wire mesh



Materials used for ferrocement

- The construction in ferrocement may be divided into 4 stages:
 - Fabrication of skeleton frame
 - Fixing of bars and mesh
 - Application of mortar
 - Curing
- The required number of layer of wire mesh are fixed on both sides of the skeleton frame. A spacing of at least 1 to 3mm is left between two mesh layers. Mortar can be applied by hand or by shortcreting. No formwork is required for ferro-cement construction.

Applications of Ferro-cement

- Mobile homes
- Water tight structures
- Silos and bins
- Boat hulls
- Biogas holders
- Pipes
- Folded Plates
- Shell roofs
- Kiosks
- Wind tunnel
- Swimming pool
- Curved benches for parks, etc.

Advantage of Ferro-Cement

- Ferro-cement structures are thin and light. Therefore, self weight of structure and foundation cost are reduced.
- The construction techniques is simple and does not require highly skilled labour.
- It is suitable for manufacturing the pre-cast concrete elements.
- Partial or complete elimination of formwork is possible.
- It is very easy to repair the damaged ferro-cement work.

High Strength Concrete

- Based on the compressive strength; concrete is normally classified as normal strength concrete, high strength concrete and ultra strength concrete. Indian standard recommended methods of mix design denotes the boundary at 35 Mpa between normal strength and high strength concrete.
- The advent of prestressed concrete techniques has given impetus for making concrete of higher strength. High strength concrete is necessary for the construction of high rise building and long span bridges.
- To achieve high strength, it necessary to use high cement content with the lowest possible W/C ratio which invariable affect the workability of the mix. It should be remembered that high cement content may liberate large heat of hydration causing rise in temperature which may affect setting and may result in excessive shrinkage.

Various methods of producing high strength concrete are:

- (i) Seeding
- (ii) Revibration
- (iii) Inhibiting Cracks
- (iv) Using admixtures
- (v) Sulphur impregnation
- Seeding is a process of adding a small quantity of finely ground, fully hydrated Portland cement to the fresh concrete mix.
- Revibration of plastic concrete also improves the strength of concrete. Concrete undergoes plastic shrinkage. Mixing water creates continuous capillary channels and bleeding, reducing strength of concrete. Revibration removes all these defects and increases the strength of concrete.

Various methods of producing high strength concrete are:

- In conventional concrete, micro-cracks develop even before loading because of drying shrinkage and other volume change. When the structure is loaded the micro cracks open up and propagate. The weakness can be removed by inclusion of small, closely spaced and uniformly dispersed fibers in concrete.
- Use of water reducing agents are known to produce increased compressive strength.

High Performance Concrete

- The development of high performance concrete (HPC) is a giant step in making concrete a high-tech material with enhanced characteristics and durability. High performance concrete is an engineered concrete obtained through a careful selection and proportioning of its constituents. The concrete is with the same basic ingredients but has a totally different microstructure than ordinary concrete.

High Performance Concrete



- The low water cement ratio of HPC results in a very dense microstructure having a very fine and more or less well connected capillary system.
- The dense microstructure of HPC, makes the migration of aggressive ions more difficult, consequently HPC is more durable when exposed to aggregate environment conditions.
- High performance concrete can hence be defined as an engineered concrete with low water/ binder ratio to control its dimensional stability and when receive an adequate curing.
- The cementitious component of high or any combination of cementitious material such as slag, flyash, silica fume, metakaolin and filler such as, limestones.

High Performance Concrete

- Concrete compressive strength is closely related to the density of hardened matrix. High performance concrete has also taught us that the coarse aggregate can be the weakest link in concrete when the strength of hydrated cement paste is drastically increased by lowering the water/binder ratio. In such case concrete failure can start to develop within the coarse aggregate itself. As a consequence, there can be exceptions to the water/ binder ratio law when dealing with HPC. When the concrete's compressive strength is limited by the coarse aggregate, the only way to get higher strength is to use a stronger aggregate.
- If water curing is essential to develop the potential strength of cement in plain concrete, early water curing is crucial for high-performance concrete in order to avoid the rapid development of autogenous shrinkage and to control concrete dimensional stability, as explained below.

High Performance Concrete

- The hydration of cement paste is accompanied by an absolute volume contraction that creates a very fine pore network within the hydrated cement paste. This network drains water from coarse capillaries, which start to dry out if no external water is supplied. Therefore, if no drying is occurring and no external water is added during curing, the coarse capillaries will be empty of water as hydration progresses. This phenomenon is called self desiccation. The difference between drying and self-desiccation is that, when concrete dries water evaporates to the atmosphere, while during-self desiccation water stay within the concrete i.e. It only migrates towards the very fine pores created by the volumetric contraction of the cement paste.

- HPC must be cured quite differently from ordinary concrete because of the difference in shrinkage behavior. The ordinary concrete exhibits no autogenous shrinkage whether it is water cured or not, whereas HPC can experience significant autogenous shrinkage if it is not water cured during the hydration process. While curing membranes provide adequate protection for ordinary concrete, they can only help prevent the development of plastic shrinkage in HPC. They have no value in inhibiting autogenous shrinkage. Therefore, the most critical period for any HPC runs from placement or finishing up to 2 to 3 days later. During this time the most critical period is usually from 12 to 36 hours. In fact, the short time during which efficient water curing must be applied to HPC can be considered a significant advantage over ordinary concrete.. In fact, the short time during which efficient water curing must be applied to HPC can be considered a significant advantage over ordinary concrete.

- Water ponding, whenever possible or fogging are the best ways to cure HPC. The water curing can be stopped after 7 days because most of the cement at the surface of concrete will have hydrated
- A specially designed high performance, self-leveling, non shrink, pre-blended concrete was formulated and was put into use against the aggressive chemical environment at fertilizer plant in Gujarat- Gujarat Narmada valley Fertilizers Ltd. (GNFC)- Bharuch. The system has been applied in 1997 and there are no signs of deterioration observed since then.

Precast Concrete

- When mass concrete work is required for huge and speedy construction work, precast concrete is used. Precast concrete elements are manufactured in industries and transported to site. They are casted in separate forms and placed in the structure on site.
- Hollow and solids concrete blocks of desired shape and size are prepared and cured in water tanks at industrial sheds and then placed on site.

Application of Precast Concrete

- Beam
- Columns
- Slabs
- Water Tanks
- Bridge girders
- Bridge Piers
- Concrete Piles
- Cessions
- Compound wall poles
- Electricity Poles
- Ornamental Structures
- Concrete lintels
- Water supply RCC Pipes
- Sewer Pipes

THANKS