



**SATHYABAMA**

INSTITUTE OF SCIENCE AND TECHNOLOGY  
(DEEMED TO BE UNIVERSITY)

Accredited "A" Grade by NAAC | 12B Status by UGC | Approved by AICTE

[www.sathyabama.ac.in](http://www.sathyabama.ac.in)

SCHOOL OF BIO AND CHEMICAL ENGINEERING

DEPARTMENT OF CHEMICAL ENGINEERING

**UNIT – 1-5 MECHANICAL OPERATIONS SCH1201**

UNIT - I

## PARTICLE ANALYSIS

INTRODUCTION

- Solids appear in variety of forms like angular pieces, continuous sheets and finely divided powder.
- They may be hard and abrasive, tough and rubbery, soft (or) fragile, dusty, cohesive, free flowing and sticky.
- They are characterized by size, shape, density and colour.
- Homogenous particles have same density.
- Size and shape are easily specified for regular particles like sphere and cubes.
- For irregular particles like sand, grains etc., size and shape are not clear and are defined as shape factor or sphericity.
- Shape of an individual particle is conveniently expressed in term of which is independent of particle size.

For non spherical particlessphericity( $\phi_s$ )

$\phi_s = \frac{\text{surface area to volume ratio of sphere}}{\text{surface area to volume ratio of that particle}}$

surface area to volume ratio of that particle

$\phi_s=1$ , For spherical particle of diameter ( $D_p$ ).

- For irregular particles  $\phi_s < 1$
- crushed particles  $\phi_s = 0.6$  and  $0.7$
- Diameter specified for equidimension particles

$$= (\pi D_p^2 / \pi D_p^3 / 6) / (S_p / V_p)$$

$$\phi_s = 6V_p/D_p S_p$$

$D_p$  - nominal for Equivalent diameter of sphere

$S_p V_p$  - Volume and surface area of irregular particle

### **Shape factor ( $\lambda$ )**

$$\lambda = b/a$$

Where a and b geometric constants shape of an individual is conveniently expressed in terms of a shape factor  $\lambda$ .

- volume of a particle of any shape can be written as

$$V_p = aD_p^3$$

- surface area of any particle

$$S_p = 6D_p^2$$

Ratio between volume to surface area is

$$V_p/D_p = aD_p^3/6b(D_p)^2$$

$$V_p/D_p = D_p/6\lambda$$

### **Size range of particles (or) size expression**

- Coarse particles- m, cm, inch, ft
- Fine particles- mesh size(screens)
- Very fine particles- micrometer , nanometer
- Ultra fine particles- specific surface area( $A_w$ ), ( $m^2/kg, cm^2/g$ )

### **Mesh:-**

- It is the number of opening per linear inch
- It is used to define the size of particle in screen
- Testing sieves are made of wire, Each opening is a square.

**Standard screens series are available.**

- Tylor standard screen series(TSS)
- British standard screen series(BSS)
- American society for Testing Machine(ASTM)

Commonly used standard screen series -> TSS

$$D_n/D_{n+2} = \sqrt{2}$$

**Mixed particle size Analysis**

Sample of uniform particles having diameter ( $D_p$ )

Total volume of the particle ( $v$ ) =  $m/\rho_p$

$m$ - total mass of the particle

$\rho_p$ - density of the particle

Total volume =  $NV_p$

Therefore,  $N = \text{Total volume}/V_p = m/V_p \text{----->}$  1

Total surface area of the particle ( $A_w$ ) =  $NS_p \text{----->}$  2

We know that,

$$\phi_s = 6V_p/D_p S_p$$

$$S_p = 6V_p/D_p \phi_s \text{----->} \quad 3$$

Substitute 1,2 in 3

$$\text{Total surface area } (A_w) = 6m / \phi_s \rho_p D_p \text{ -----} > \quad 4$$

2 and 4 applied for mixture of particles having sizes and density, mixture is sorted into fractions. Each fraction can be weighed (or) individual particles can be counted (or measured) by using microscopic method.

### Specific surface area ( $A_w$ ) for a mixture of particles

$$A_w = 6m / \phi_s \rho_p D_p$$

where m - mixture of particles as mass fraction  $x_i$

$$A_w = 6x_1 / \phi_s \rho_p D_{p1} + 6x_2 / \phi_s \rho_p D_{p2} + \dots + 6x_n / \phi_s \rho_p D_{pn}$$

$$A_w = 6 / \phi_s \rho_p \sum_{i=1}^n x_i / D_{pi} \text{ -----} \quad 5$$

### By different analysis

$$D_s = 1 / \left[ \sum \Delta \phi_m / D_n \right]$$

Where  $\Delta \phi_m$  = mass fraction retained

### By a cumulative analysis

$$D_s = 1 / \left[ \int_0^1 \phi_n / D_{pi} \right]$$

$\phi_n$  = Cumulative mass fraction

### Arithmetic Mean Diameter

$$D_N = \sum_{i=1}^n (N_i D_{pi}) / N_T$$

$D_p$  = particle diameter in the particle increment

$N_T$  = number of particles present in the entire sample

$N_i$  = number of particles in that particular increment

### Mass mean Diameter

$$D_w = \int_0^1 D_p d\phi$$

### Volume Mean Diameter

$$D_v = \frac{\sum n_i d_i^4}{\sum n_i d_i^3}$$

$n_i$  = Number of particle per unit mass

$d_i$  = diameter of particle for a particular diameter

Where  $i = 1, 2, 3, \dots, n$  (increment)

$x_i$  = mass fraction in the increment

$n$  = number of increment

$D_{pi}$  = Average particle diameter

$\phi_s, \rho_p$  = Sphericity and Density remains same.

### Differential and Cumulative Analysis

Information from such a particle-size analysis is tabulated to show the mass or number fraction in each size increment as a function of the average particle size (or size range) in the increment. An analysis tabulated in this way is called a *differential analysis*. The results are often presented as a histogram, as shown in Fig. with a continuous curve like the dashed line used to approximate the distribution. A second way to present the information is through a *cumulative analysis* obtained by adding, consecutively, the individual increments, starting with that containing the smallest particles, and tabulating or plotting the cumulative

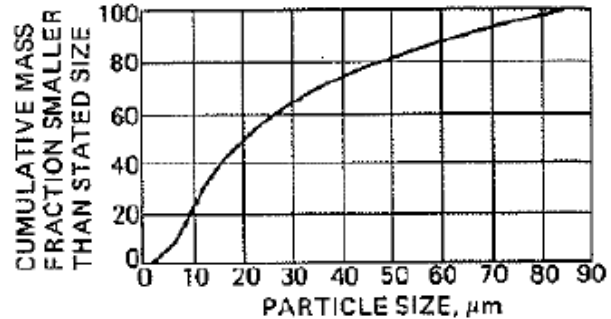
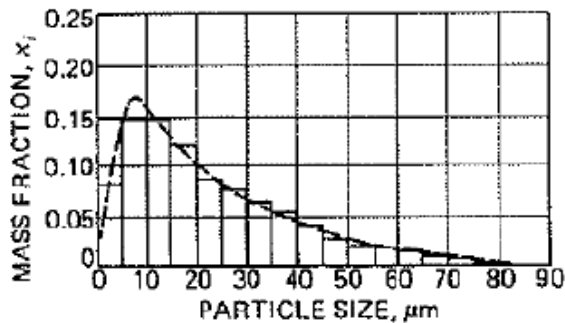

### Analytical representation of particle size

- Volume surface mean diameter
- Arithmetic mean diameter
- Mass mean diameter
- Volume mean diameter
- Surface mean diameter
- Linear mean diameter

#### 1) Volume surface mean diameter

$$D_s = \frac{6}{A_w \phi_s \rho_p} \sum_{i=1}^n x_i / D_{pi} \quad 1$$

We have  $A_w = \frac{6}{\phi_s \rho_p} \sum_{i=1}^n x_i / D_{pi} \quad 2$

Therefore  $D_s = \frac{1}{\sum_{i=1}^n x_i / D_{pi}} \quad 3$

#### 2) Surface Mean Diameter

$$D_s = \frac{\sum n_i d_i^3}{\sum n_i d_i^2}$$

3) Linear Mean diameter

$$D_l = \frac{\sum x_i/d_i}{\sum x_i/d_i^2}$$

Number of particle in the ( $N_w$ )

$$N_w = \frac{1}{a \rho_p} \left( \sum_{i=1}^n x_i / D_{pi}^3 \right)$$

a=volume shape factor

$\rho_p$ =density of particle

$x_i$ =mass fraction

Screen Analysis

Assumption:- All the particles return in a single fraction are equal in shape and size is a arithmetic mean average of the mesh dimensions of the screen which define the fraction.

example: size of 10/14 mesh fraction= (1.651+1.168) /2

$D_{pi} = 1.410\text{mm}$

Screen blindness

Under the screening action elongated sticky flacky or soft particles may become wedged into particles from passing through screen. A screen plugged with solid particles is turn to be screen blindness.

**Methods for Determining Particle Size**

1. Microscopy
2. Sieving
3. Sedimentation techniques
4. Electrical sensing zone method – Coulter Counter
5. Laser Diffraction Method



## 6. Permeametry Technique

### Microscopy

#### Optical microscopy (1-150 $\mu\text{m}$ )

##### Electron microscopy (0.001 $\mu\text{m}$ -)

Being able to examine each particle individually has led to microscopy being considered as an absolute measurement of particle size.

Can distinguish aggregates from single particles

When coupled to image analysis computers each field can be examined, and a distribution obtained.

Number distribution

Most severe limitation of optical microscopy is the depth of focus being about 10 $\mu\text{m}$  at x100 and only 0.5 $\mu\text{m}$  at x1000.

With small particles, diffraction effects increase causing blurring at the edges - determination of particles < 3 $\mu\text{m}$  is less and less certain.

#### Manual Optical Microscopy

##### Advantages

- o Relatively inexpensive
- o Each particle individually examined - detect aggregates, 2D shape, colour, melting point etc.
- o Permanent record - photograph
- o Small sample sizes required

##### Disadvantages

- o Time consuming - high operator fatigue - few particles examined
- o Very low throughput
- o No information on 3D shape
- o Certain amount of subjectivity associated with sizing - operator bias

#### Transmission and Scanning Electron Microscopy

##### Advantages

- o Particles are individually examined
- o Visual means to see sub-micron specimens
- o Particle shape can be measured

##### Disadvantages

- o Very expensive
- o Time consuming sample preparation
- o Materials such as emulsions difficult/impossible to prepare
- o Low throughput - Not for routine use

**Automatic and Image Analysis Microscopes****Advantages**

- o Faster and less operator fatigue than manual
- o No operator bias

**Disadvantages**

- o Can be very expensive
- o No human judgement retained e.g. to separate out aggregates, select or reject particles etc. (unlike semi-automatic)

**Sieving**

A sieve analysis (or gradation test) is a practice or procedure used to assess the particle size distribution (also called *gradation*) of a granular material.

The size distribution is often of critical importance to the way the material performs in use. A sieve analysis can be performed on any type of non-organic or organic granular materials including sands, crushed rock, clays, granite, feldspars, coal, soil, a wide range of manufactured powders, grain and seeds, down to a minimum size depending on the exact method. Being such a simple technique of particle sizing, it is probably the most common.

Sieve analysis is performed using a nest or stack of sieves where each lower sieve has a smaller aperture size than that of the sieve above it. Sieves can be referred to either by their aperture size or by their mesh size (or sieve number).

The mesh size is the number of wires per linear inch.

Approx. size range : 5 $\mu$ m - ~3mm

**Purpose**

This test is performed to determine the percentage of different grain sizes

- o contained within a soil. The mechanical or sieve analysis is performed to
- o determine the distribution of the coarser, larger-sized particles, and the hydrometer
- o method is used to determine the distribution of the finer particles.

**Advantages**

- o Easy to perform
- o Wide size range
- o Inexpensive

**Disadvantages**

- o Known problems of reproducibility
- o Wear/damage in use or cleaning
- o Irregular/agglomerated particles
- o Rod-like particles : overestimate of under-size
- o Labour intensive

**Sedimentation Technique**

Methods depend on the fact that the terminal velocity of a particle in a fluid increases with size.

Stokes's Law :

$$v = \frac{(\rho_s - \rho_f)gd_{sph}^2}{18\eta}$$

$$d_{sph} = \sqrt{\frac{18\eta}{(\rho_s - \rho_f)g} \frac{x}{t}}$$

Stokes' diameter (dst) is defined as the diameter of the sphere that would settle at the same rate as the particle.

The particle size distribution of fine powder can be determined by examining a sedimenting suspension of the powder.

**2 categories**

(1) Incremental : changes with time in the concentration or density of the suspension at known depths are determined. Can be either fixed time or fixed depth techniques.

(2) Cumulative : the rate at which the powder is settling out of suspension is determined. i.e the accumulated particles are measured at a fixed level after all particles between it and the fluid's surface have settled.

**Andreasen Pippette:**

Size distribution is determined by allowing a homogeneous suspension to settle in a cylinder and taking samples from the settling suspension at a fixed horizontal level at intervals of time.

**Advantages**

- o Equipment required can be relatively simple and inexpensive.
- o Can measure a wide range of sizes with considerable accuracy and reproducibility.

**Disadvantages**

- o Sedimentation analyses must be carried out at concentrations which are sufficiently low for interactive effects between particles to be negligible so that their terminal falling velocities can be taken as equal to those of isolated particles.
- o Large particles create turbulence, are slowed and are recorded undersize.
- o Careful temperature control is necessary to suppress convection currents.
- o The lower limit of particle size is set by the increasing importance of Brownian motion for progressively smaller particles.

- o Particle re-aggregation during extended measurements.
- o Particles have to be completely insoluble in the suspending liquid.

### **Electrical sensing zone method – Coulter Counter**

Instrument measures particle volume which can be expressed as  $dv$  : the diameter of a sphere that has the same volume as the particle.

The number and size of particles suspended in an electrolyte is determined by causing them to pass through an orifice on either side of which is immersed an electrode.

The changes in electric impedance (resistance) as particles pass through the orifice generate voltage pulses whose amplitude are proportional to the volumes of the particles.

### **Laser Light Scattering Techniques**

Laser-based techniques for particle-size measurement have become increasingly important in combustion research and many other disciplines. Instruments are continually being developed and improved to meet the demanding geometric, accuracy and other requirements associated with current research and industrial applications. This paper reviews some of the many techniques now used, including those marketed as commercial instruments and those ideas still in the research stage. Two distinct classes of methods are identified: amplitude dependent and amplitude independent. The operating principles of particle-size instrumentation using laser-based techniques, as well as difficulties associated with applying these methods, are discussed. Applications of some techniques in research and industrial situations are also reviewed. The paper provides a comprehensive review for those who are beginning studies in, or starting to apply, any particle-sizing method based on laser illumination.

Laser Diffraction Particle Size Analysis

(Particle size range 0.02-2000 $\mu\text{m}$ )

Photon Correlation Spectroscopy

(Particle size range :1nm to 5 $\mu\text{m}$ )

Laser diffraction:

Particles pass through a laser beam and the light scattered by them is collected over a range of angles in the forward direction.

The angles of diffraction are, in the simplest case inversely related to the particle size.

The particles pass through an expanded and collimated laser beam in front of a lens in whose focal plane is positioned a photosensitive detector consisting of a series of concentric rings.

Distribution of scattered intensity is analysed by computer to yield the particle size distribution.

### **Advantages**

- o Non-intrusive : uses a low power laser beam.
- o Fast : typically <3minutes to take a measurement and analyse.
- o Precise and wide range - up to 64 size bands can be displayed covering a range of up to 1000,000:1 in size.
- o Absolute measurement, no calibration is required. The instrument is based on fundamental physical properties.
- o Simple to use.

o Highly versatile.

### **Disadvantages**

o expensive

o volume measurement all other outputs are numerical transformations of this basic output form, assuming spherical particles

o must be a difference in refractive indices between particles and suspending medium

### **Permeametry Technique**

Determination of the average size of fine particles in a fluid (gas or liquid) by passing the mixture through a powder bed of known dimensions and recording the pressure drop and flow rate through the bed.

The air permeametry of powder beds of some coarse particulate solids with varying particle size and shape characteristics were measured. The specific surface area of each powder was calculated using the Kozeny-Carman equation. The air flow conditions through the powder bed were evaluated by the Reynolds number. The materials were examined in microscope to determine particle size and shape, and powder surface areas were calculated from these data. It was found that the height and the packing intensity of the powder bed did not affect the permeametry surface area. The Reynolds number indicated that the flow type was acceptable for the use of the Kozeny-Carman equation. The permeametry and microscopy derived surface areas correlated well although slightly higher surface area values were generally obtained with the permeametry technique. It is concluded that the air permeametry method can be used for the measurement of the external surface area of coarse particulate materials. For porous materials the granule density, rather than the true density, should be used for calculating the surface area.

## **Screening Equipments**

### **Types of Screening Equipments**

- Grizzlies (fixed inclined screens) are used for the coarse screening of large lumps.
- Trommels (revolving screens) are generally used for fairly large particles.
- Shaking and vibrating screens are used in a coarse range and also down into fine meshes (fine sizing).
- Oscillating screens are used for the finer meshes below 4 mesh.

### **Grizzlies / Grizzly Screens**

#### **Construction:**

- Grid of parallel metal bars set in an inclined stationary frame, with slope of 30 to 45°.

- Slope and the path of the material are parallel to the length of the bars.
- The length of the bar may be upto 3m and the spacing between the bars is 50 to 200 mm.
- Material of construction of the bars is manganese steel to reduce wear.
- Bar is shaped in such a way that its top is wider than the bottom.
- It can be made fairly deep for strength without being choked by lumps passing part way through them.

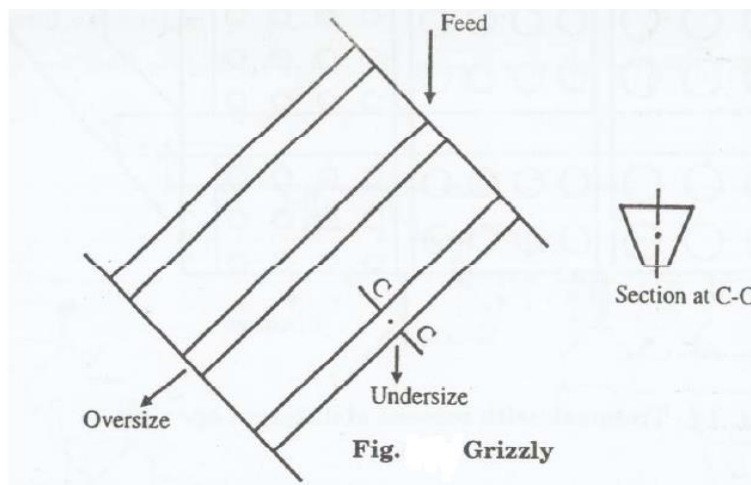

### Working

- A coarse feed is fed at the upper end of the grizzly.
- Large chunks roll and aside to the lower end while small lumps having size less than the opening in the bars fall through the grid into a separate collector.
- If the angle of inclination to the horizontal is greater, greater is the output but the lower is the screen efficiency.

### Advantages

- Simplest of all separating devices.
- Requires no power.
- Least expensive to install and maintain.

## Trommels

### Construction

It consisting of a cylindrical frame surrounded by wire cloth or perforated plate.

- They are open at one or both ends.
- Inclined at a slight angle to the horizontal so that the material is advanced by the rotation of the cylinder.
- It revolve at relatively low speeds of 15 to 20 rpm.
- Perforations in the screening surface may be of the same size throughout or may be of different size in which the small size perforation section is near the feed end.
- It is driven at the feed end through a gear mechanism.
- It has a feed point at the upper end, an undersize product discharge below the screening surface and a oversize discharge at the opposite end.

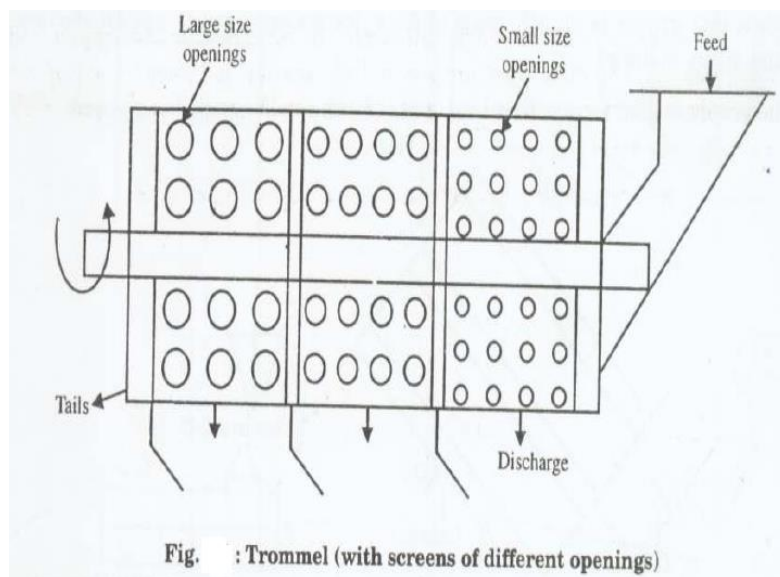

### Working

- The material to be screened is fed at the upper end and gradually moves down the screening surface towards the lower end.
- As the material passes over the aperture gradually increasing size.

- If the single cylinder provided with the screen having three different size perforations then we get four fractions.
- The finest material is collected as the underflow in the compartment near feed end and the oversize material is withdrawn from the discharge end.
- Such type of arrangement is usually adopted for smaller capacities.

#### Comparison of Grizzlies and Trommels

Grizzlies	Trommels
Stationary inclined screens	Revolving screens
Screen is a grid of metal bars	Screen is a perforated cylindrical member
Openings in screen are large	Openings in screen are small
They handle large size feed	They handle small size feed
Capacity is large	Capacity is relatively small
Labour requirement is large	Labour requirement is low
Cheap construction	Relatively expensive construction

#### Vibrating screens

Screens which are rapidly vibrated with small amplitude keep the material moving and prevent binding as far as possible. Vibrating screen are commonly used in industry where large capacity and high efficiency are desired. These screens are classified as mechanically vibrated screens and electrically vibrated screens.

#### Operation

- Vibrations are given to screen to effect the separation of solid particles in to size fractions.
- Vibrating screen three decks.

#### Variables in screening operation

- Method of feeding-m material should spread
- Screening surface –angle speed amplitude of vibration
- Screen slope



- Vibration amplitude and frequency
- Moisture in the feed

### GYRATING SCREENS

A heavy duty gyrating screen is shown in figure. Two screens one above the other are held in a casing inclined at an angle between  $16^{\circ}$  and  $30^{\circ}$  with the horizontal. The feed mixture is dropped on the upper screen near its highest point. Casing and screens are gyrated in a vertical plane about a horizontal axis by an eccentric that is set halfway between the feed point and the

Finer screens are usually gyrated at the feed end in a horizontal plane. The discharge end reciprocates but does not gyrate. This combination of motions stratifies the feed so that fine particles travel downward to the screen surface, where they are pushed through by the larger particles on top. Often the screening surface is double and between the two screens are rubber balls held in separate compartments. As the screen operates, the balls strike the screen surface and free the openings of any material that tends to plug them. Dry, hard, round or cubical grains ordinarily pass without trouble through screens.

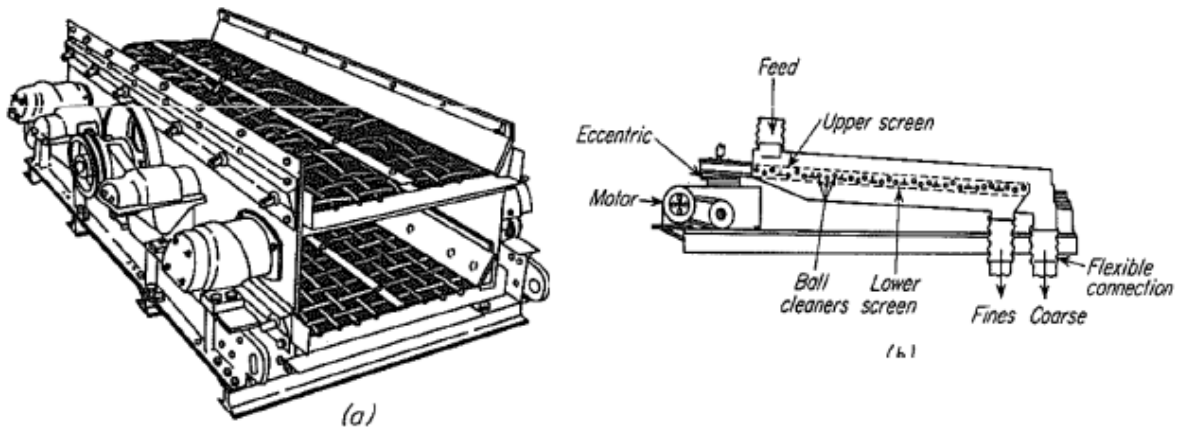

**(a) Heavy-duty vertically gyrated screen; (b) Electrically vibrated screen.**

### VIBRATING SCREENS

Screens are rapidly vibrated with small amplitude are less likely to blind than are gyrating. The vibrations may be generated mechanically or electrically. Mechanical vibrations are usually transmitted from high speed eccentrics to the casing of the unit and from there to steeply inclined screens. Electrical vibrations from heavy duty solenoids are transmitted to the casing or directly

Inclined Vibrating Screens

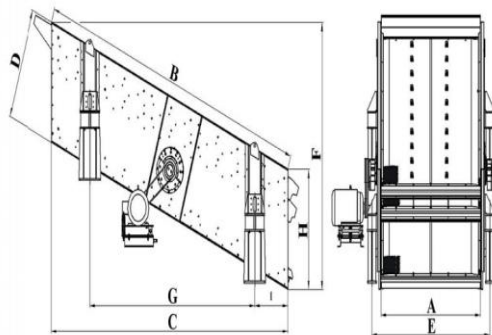

Horizontal Vibrating Screens

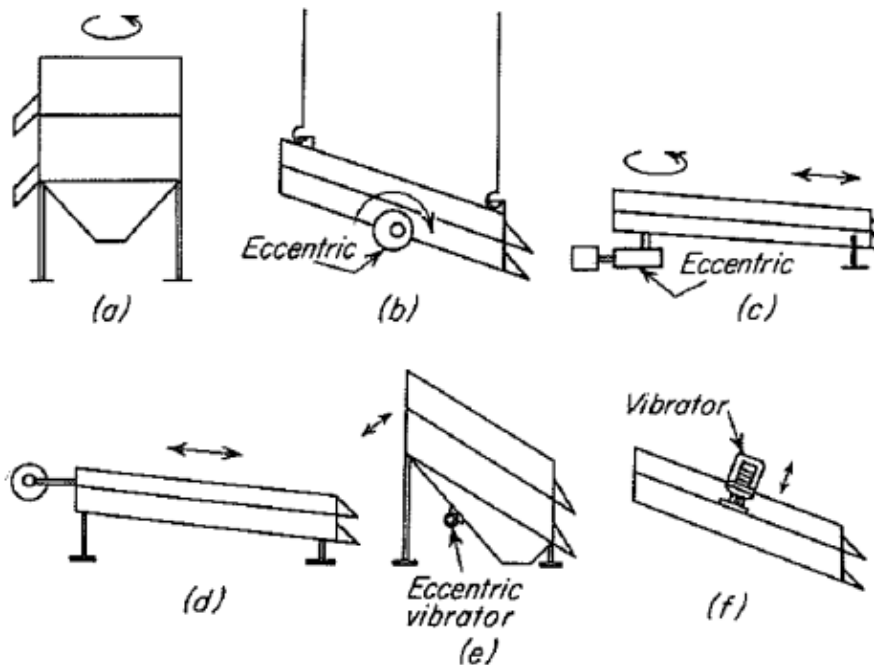
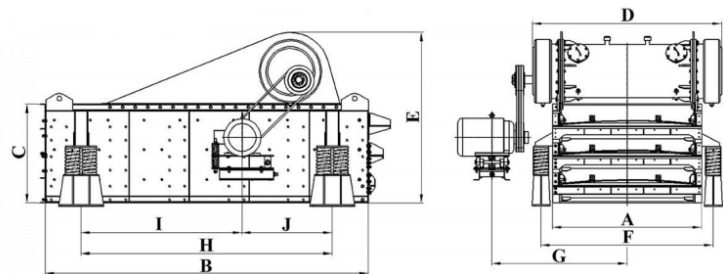

Motions of screens: (a) gyrations in horizontal plane; (b) gyrations in vertical plane; (c) gyrations at one end, shaking at other; (d) shaking; (e) mechanically vibrated; (f) electrically vibrated.

to the screens. Figure shows a directly vibrating screens. Between 1800 and 3600 vibrations per minute are usual.

**Screen effectiveness**

The effectiveness of the screen often called screen efficiency. It is a measure to the success a screen. The effectiveness based on material 'D' in overflow to the amount of 'D' entering with feed. Similarly the effectiveness based on material 'B' in underflow to the amount of 'B' entering with feed.

Effectiveness of a screen is found by

Let F= mass flow rate or amount of feed

D= mass flow rate or amount of overflow

B= mass flow rate or amount of underflow

Overall material balance is given by

$$F=D+B \quad \text{_____} \quad 1$$

$X_f$  = mass fraction of 'D' in feed

$X_d$  = mass fraction of material 'D' in overflow

$X_b$  = mass fraction of material 'D' in underflow

$1-X_f$  = mass fraction of material 'B' in feed

$1-X_D$  = mass fraction of material 'B' in overflow

$1-X_B$  = mass fraction of material 'B' in underflow

**Mass balance for material D and B**

Mass balance for A

$$FX_F = DX_D + BX_B \quad \text{_____} \quad 2$$

from equation 1

$$B = F - D \quad \text{_____} \quad 3$$

substitute 3 in 2

$$F x_F = D x_D + (F - D) x_B$$

$$F(x_F - x_B) = D(x_D - x_B)$$

$$D/F = (x_F - x_B)/(x_D - x_B)$$

Mass balance of material 'B'

$$F(1 - x_F) = D(1 - x_D) + B(1 - x_B) \quad \text{_____} \quad 4$$

from 1 w.k.t,

$$D = F - B \quad \text{_____} \quad 5$$

Substitute 5 in 4

$$F(1 - x_F) = (F - B)(1 - x_D) + B(1 - x_B)$$

$$F(x_D - x_F) = B(x_D - x_B)$$

$$B/F = (x_D - x_F)/(x_D - x_B)$$

Effectiveness based on material D is ratio of material D in overflow to the material D in feed

$$E_A = D x_D / F x_F$$

$$E_A = (x_F - x_B) x_D / (x_D - x_B) x_F$$

similarly

$$E_B = (1 - x_B) B / (1 - x_F) F$$

$$E_B = (1 - x_B)(x_B - x_F) / (1 - x_F)(x_D - x_B)$$

overall effectiveness 'E' is defined as the product of two individual ratios

$$E = E_A \times E_B$$

$$E = \frac{(x_F - x_B)x_D / (x_D - x_B)x_F}{(1 - x_B)(x_B - x_F) / (1 - x_F)(x_D - x_B)}$$

$$E = \frac{(x_F - x_B)x_D (1 - x_B)(x_B - x_F)}{[(x_D - x_B)^2 x_F (1 - x_F)]} * 100$$

Where E = Screen effectiveness

### Storage of Solids

#### Types of storage

- Bulk storage (piles)
- Bin storage (Bin, silo, hopper)

#### Bulk storage

- Coarse solids like sand and coal are stored outside in large piles, unprotected from weather.
- 100 or 1000 tonne of materials are involved.
- solid stored or removed from pile by tray line or fracter shovel and delivered through the conveyor to the process
- Outdoor storage may lead to environmental problems such as dusting, leching of soluble material from the pile, dusting can be avoided by giving a protect cover to the stored solid leaching.

#### Bin storage

- Solids are for valuable or 2 soluble to expose it outdoor.
- Piles are stored in bins, silos, hoppers.

Bin -> cylindrical structure built in meal concrete

Silo -> tall and relatively small in diameter

Hopper -> Bin, slopping bottom for temporary storage

### Angle of repose

Granular solids are piled up on a flat surface; the sides of the pile are at a definite reproducible angle with the horizontal. The angle  $\alpha_r$  angle of repose.

For free flowing granular solids ->  $15^\circ$  and  $30^\circ$

## CONVEYING OF SOLIDS

### **Introduction:**

Are used for handling materials.

Used in all industries.

Consists majorly of two major components :Mechanical Assembly AND Conveying Assembly

### **Types of Conveyors:**

Belt Conveyor

Bucket Elevator

Screw Conveyor

Chain Conveyor

Pneumatic Conveyor

### **Types of Conveyors:**

#### **Belt Conveyors**

Conveys materials along horizontal, and slightly inclined paths

Driven by power operated roll mounted underneath the conveyor or at the one end of the conveyor.

supported on either rollers or on metal slider pan and we call them roller conveyor and slider conveyor respectively

#### **Advantages & Disadvantages :**

Advantages & Disadvantages

Convey almost any type of solid material

Easy to adapt to plant layout

Inclination angle must be less than 22 degrees

Cannot transport anything greater than 120 degrees

**Types of Conveyors:****Bucket Elevators**

Used where there is need of vertical conveying of materials.  
Used for conveying powdered, granular and lumpy materials.  
Extensively employed in building materials chemical industries plant etc.

**Types of Conveyors:****Screw Conveyors**

These are the oldest and are of simple design, easy to maintain.  
Permits intermediate discharge of materials at several points .  
Advantages being these are compact and easily adapted to congested locations  
Horizontal, vertical, inclined conveyors are also available.

**Types of Conveyors:****Pneumatic Conveyors**

Involves the transportation of a wide variety of dry powdered and granular solids in a gas stream.  
In most cases the gas is normally air.  
Where special conditions prevail, different gases are used.

**Pneumatic conveyers :****Advantages:**

Flexibility in routing  
Dust free transportation of a variety of products  
Mechanical parts are at ground level  
Units are self cleaning & safer to operate

**Disadvantages:**

Energy requirements are higher  
Material must be dry  
Incorrect design can result in particle degradation  
More noisy  
Limited distance

**Size Specification:**

Size depends on the requirement :

Speed

Cost

Efficiency

Maximum load it takes

Length of travel

**Industrial Applications:**

Packing

Inspecting

Painting

Assembling

Testing



UNIT- II**INTRODUCTION TO SIZE REDUCTION EQUIPMENTS****Introduction**

- Solid particles are cut or broken into small pieces throughout the process.
- Sizes of the solids are reduced into different methods for various process.
- It may be broken into 8 or 9 ways.
- Size reduction machines by applying forces like
  - Compression force -> Not crackers (coarse)
  - Impact force -> Pounding with hammer(coarse, intermediate, fine)
  - Attrition or rubbing force -> file (ultra fine)
  - cutting force -> pair of shears
  - Tensile or shear force

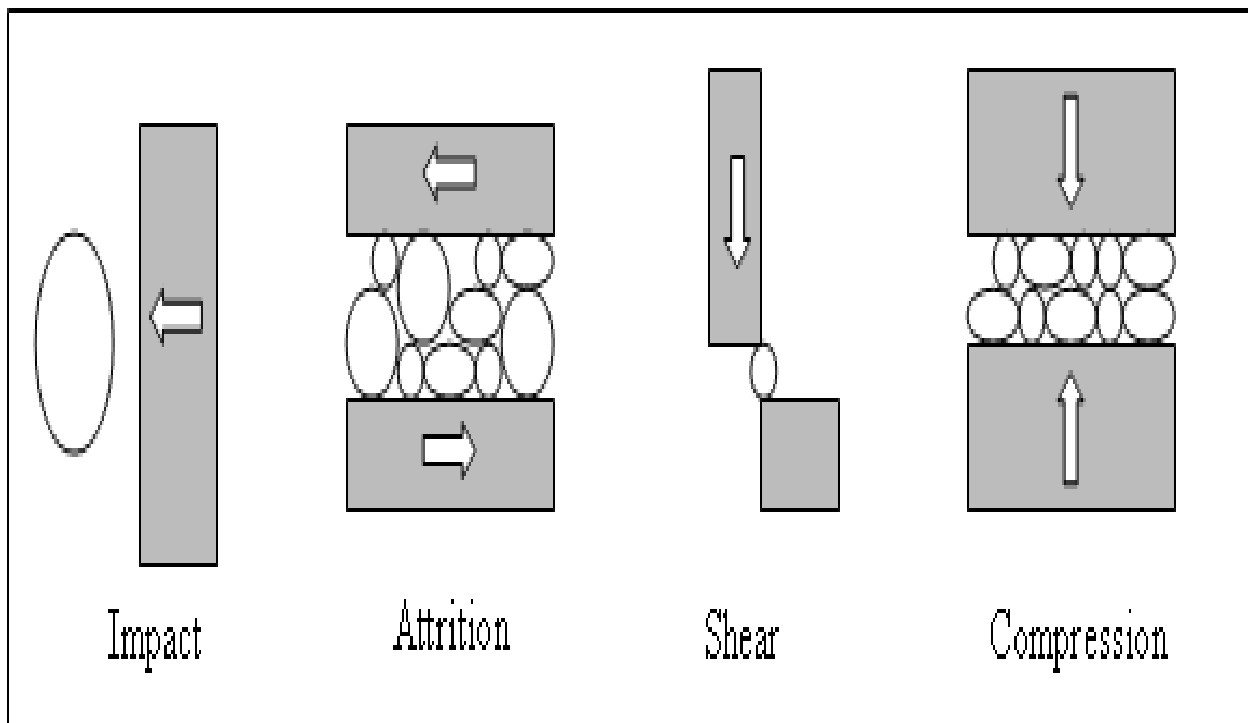

### **Principle of comminution**

- Criteria for comminution.
- Character of comminution.
- Energy and power requirements for comminution.

### **Criteria for comminution**

Comminution is a generic term for size reduction crusher and grinders are types of comminuting equipments. An ideal crusher or grinder would have

- Large capacity
- Require small power input for unit of product
- Yield a Product of single size

### **Characteristics of comminuted products**

- Objective of crushing and grinding into produce small particles from larger ones.
- Energy measured by the new surface area created by reduction in size.
- Feed is homogenous -> shape, chemical and physical structure of the product may be quite uniform.

### **Energy and power requirements for comminution**

- Cost of power is a major expense in crushing and grinding operation. Therefore we must consider the factor which controls the cost.

### **Crushing efficiency ( $\eta_c$ )**

It is defines as the ration of product of surface area created to the energy absorbed by the solids

$$\eta_c = [e_s(A_{wb} - A_{wa})] / W_n$$

$e_s$  - surface energy

$A_{wb}$  - product size

$A_{wa}$  -Feed size

$w_n$ - energy absorbed by solids

### Mechanical efficiency ( $\eta_m$ )

Energy absorbed by solids ( $w_n$ ) is less than that of feed into the machinery parts of total energy ( $w$ ) which is used for rotating the machine, bearing and in other cooling parts.

Rest of energy used for material crushing. It is defined as the ratio of surface energy and new surface area created to the energy input

$$\eta_m = [e_s(A_{wb} - A_{wa})] / cW$$

$$\eta_c W = \text{energy input}$$

$$\text{Total energy } W = [e_s(A_{wb} - A_{wa})] / \eta_c \eta_m$$

If  $m$  is the feedway then the power required by machinery is given by

$$P = [m e_s (A_{wb} - A_{wa})] / n.n$$

We know that

$$\text{Total surface area } (A_w) = 6m / \phi_s \rho_p D_p$$

$$P = m e_s / \eta_c \eta_m [(6 / \phi_s \rho_p D_{sb}) - (6 / \phi_s \rho_p D_{sa})]$$

$$P = 6 m e_s / \eta_c \eta_m \phi_s \rho_p [1 / D_{sb} - 1 / D_{sa}]$$

## Law of comminution or size reduction laws

### Rittingers law

The work required for crushing is directly proportional to the new surface area created

we know that,

$$P = 6 m e_s / \eta_c \eta_m \phi \rho_p [1 / \phi_{sb} D_{sb} - 1 / D_{sa} \phi_{sa}]$$

If the  $\phi_{sb}$  and  $\phi_{sa}$  are equal, mechanical efficiency is also constant for particular machine, then the various constant in the above equation can be combined as a single constant  $K_r$  (Rittingers constant).

$$p/m = K_r [1 / D_{sb} - 1 / D_{sa}]$$

### Kick's law

The energy required for crushing a given mass of material is directly proportional to the logarithmic reduction ratio.

### Reduction ratio

A ratio of initial particle size to final particle size, also this law states energy required the same when the reduction ratio remains the same.

$$p/m = K_b \ln [D_{sa} / D_{sb}]$$

### Bond's law

The work required to form particle of size  $D_p$  from a very large feed is proportional to the square root of surface to volume ratio of the particle in product ( $S_p/V_p$ ).

$$p/m \propto \sqrt{S_p / V_p}$$

$$S_p = \pi D_p^2 \quad V_p = D_p^3 / 6$$

$$S_p / V_p = \pi D_p^3 / 6$$

$$p/m \propto \sqrt{6 / D_p}$$

$$p/m = K_b [1 / \sqrt{D_{sb}} - 1 / \sqrt{D_{sa}}] \quad 1$$

$K_b$  = Bonds constant depends on type of machine

### Work Index ( $W_i$ )

It is defined as gross energy in Kw-hr / tonne for a particle of very large feed is reduced to such a size that 80% of product pass through 100micron screen

$$p/m = K_b [1/\sqrt{D_p}]$$

$$W_i = K_b [1/0.3162]$$

$$K_b = 0.3162 W_i \text{_____}^2$$

Substitute 2 in 1

$$p/m = 0.3162 W_i [1/\sqrt{D_{sb}} - 1/\sqrt{D_{sa}}]$$

$W_i$  includes the friction in crusher and power given by the above equation is gross power.

### List of Crushing equipments

<u>Coarse Crushers</u>	<u>Intermediate crushers</u>	<u>Fine grinders</u>
Stage or Blake	Crushing rolls	Colloidal mill
Dodge jaw crusher	Disk crusher	Ball mill
Gyratory crusher	Edge runner	Rod mill
	Mill, Hammer mill	Tube mill
	Pin mill	Hardinge mill, fluid energy mill

<u>Type</u>	<u>Feed size</u>	<u>Product size</u>
Coarse crushers	150-5 cm	5cm-0.5cm
Intermediate crushers	5-0.5cm	0.5cm-200mesh
Fine grinders	0.5cm-0.2cm	200 mesh
Ultra fine grinding	80 mesh	$0.01 \times 10^{-6}$
cutters	Defined ore Irregular shape	Defined ore Regular shape

### Alternative derivation in crushing laws

A number of empirical law have been put forward to estimate the amount of energy required for size reduction,

Rittinger's law, Bond's law, Kick's law

Basic equation for deriving laws is

$$dE/dL = -CL^p \quad \text{1}$$

Above equation states that energy  $dE$  requires to effect a small change  $dL$  in size for a unit mass of material is a simple power function of size.

Put  $P = -2$  in equation 1

$$dE/dL = -CL^{-2}$$

$$dE/dL = -C/L^2$$

$$\int_0^E dE = \int_{L_1}^{L_2} -C/L^2 dL$$

$$= -C[(1/L_2) - (1/L_1)]$$

$$\text{Putting } C = k_r f_c [(1/L_2) - (1/L_1)] \quad \text{2}$$

**Hence we obtained Rittingers's law**

put  $P = -1$  in 1

$$dE/dL = -CL^{-1}$$

$$dE = -CL^{-1} dL$$

$$E = C \ln[L]_{L_1}^{L_2}$$

$$E = C \ln(L_1/L_2)$$

put  $C = k_k f_c$

$$E = k_k f_c \ln(L_1/L_2) \quad \text{3}$$

**Hence we obtained Kick's law**

Put  $P = -3/2$

$$dE/dL = -CL^{-3/2}$$

$$dE = -CL^{-3/2} dL$$

$$E = C \int_{L1}^{L2} L^{-3/2} dL$$

$$= 2C \left[ \frac{1}{\sqrt{L2}} - \frac{1}{\sqrt{L1}} \right]$$

$$\text{Put } 2C = k_b f_c$$

$$E = k_b f_c \left[ \frac{1}{\sqrt{L2}} - \frac{1}{\sqrt{L1}} \right] \quad \text{_____ 4}$$

Hence we obtained Bond's law

$$dE/dD_p = a D_p^{-b} \quad (b=2, b=1, b=3/2)$$

## Closed and Open circuit grinding

### Open circuit grinding

If a plant is separated in such a way that the material passed only once through the equipment.

### Closed circuit grinding

As shown in figure, The product obtain from a grinding or crusher contains material of insufficiently crushed it may be necessary to separate the product and return the o/s material for second crushing. This system is generally preferred and it is known as closed circuits. Energy consumption is less when compared to open circuit grinding.

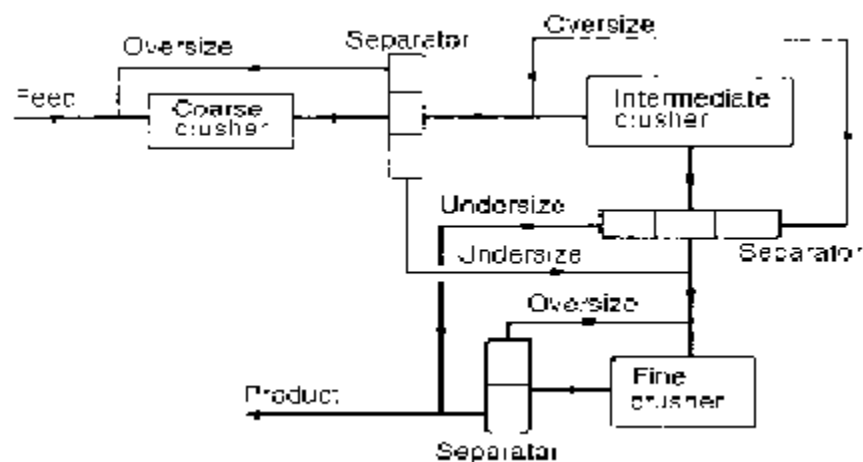

**Critical speed of a ball mill**

The speed at which the outermost ball loses the contact with the wall of the mill depends on the balance between the gravitational force and centrifugal force.

Consider a ball at point 'A' on the periphery of the mill wall. Let the radius of mill and ball be 'R' and 'r'. Let OA makes an angle  $\alpha$  with vertical. Let R-r be the distance between the center of ball and mill.

Two forces acting on the mill are

1) Gravitational force  $mg$

m- mass of ball and g-acceleration due to gravity

2) Centrifugal force acting on the mills  $=mu^2/R-r$

3) Centripetal Component of force opposing the ball fall  $=mg\cos \alpha$

As long as centrifugal force exceeds the centripetal force, the ball will not fall from the mill wall. As the mill reaches a certain speed for the ball to fall from the mill wall, two opposing forces are equal

$$mg\cos \alpha = mu^2/R-r$$

Where  $u=2\pi(R-r)N$

N=Number of rotation of the mill

$$mg\cos \alpha = m[2\pi(R-r)N]^2/R-r$$

$\alpha=0$ , at critical speed then  $N=N_c$

$$mg=m4\pi^2(R-r)^2N_c^2/R-r$$

$$g=4(R-r)N_c^2$$

$$N_c^2=g/[4\pi^2(R-r)]$$

**Centrifuging and Critical speed**



Faster the mill rotated the balls are carried along the mill wall and hence the greater power is consumed. When they are released impact on the mill is greater and we need a larger protecting capacity for mill wall. At a very high speed the balls are carried along the mill wall, it is said to be centrifuging. The speed of which a centrifuging is called critical speed. Operating speed will be less than the critical speed. 65 to 80% of  $N_c$ . Little or no grinding takes place during centrifuging.

### Cascading and cataracting

- Cascading refers the rolling of balls or pebbles from top to bottom of the trap.
- Cataracting refers throwing of balls through the air to the toe of the trap.

## Ball Mill

### Construction

Ball mill consist of a hollow cylindrical shell rotating about its axis. Axis of the shell horizontal or at small angle to the horizontal. It is partially filled with balls made up of Steel, Stainless steel or rubber. Inner surface of the shell is lined with abrasion resistant materials such as Manganese, Steel or rubber Length of the mill is approximately equal to its diameter Balls occupy about 30-50% of the volume. dia of the ball 12 mm-125 mm Shell is rotated through a drive gear (60-100 rpm) and large mills, shell might be in 3m in dia and 4.25 m in length. Operation may be batch or continuous, wet or dry in a continuously operated ball mill outlet is normally covered with coarse screen to prevent the escape of the balls.

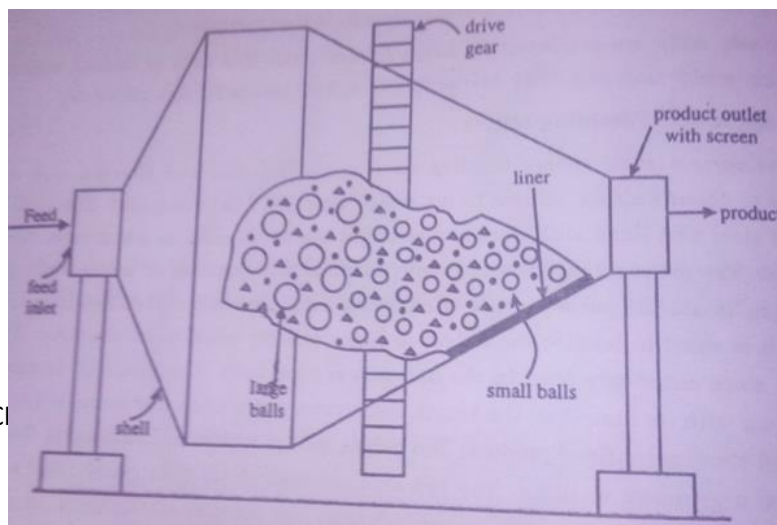

### Working

Material to be ground is fed from the left through a 60 cone and product is discharged through a 30 cone to the right. As the shell rotates the balls are lifted up on the rising side of the shell and they cascade down from near the top of the shell. The solid particles in between balls are ground and reduced in size by impact. As the shell rotates the large balls segregate near the feed end and small balls segregate near the product end. If the rate of feed is increased, coarser product will be obtained and if the speed of rotation is increased the fineness for a given capacity increases. During grinding, balls themselves wear and are continuously replaced by new ones so that mill contain balls of various ages and thus of various sizes.

### Applications

- The ball mill is used for grinding materials such as coal, pigments and feldspar for pottery.
- Grinding can be carried out in either wet or dry but the former is carried out at low speeds.

The advantages of wet grinding are less power consumption, increased capacity, no dust formation etc and disadvantages are high wear on the grinding medium and necessity to dry the product.

## JAW CRUSHER

A jaw or toggle crusher consists of a set of vertical jaws, one jaw being fixed and the other being moved back and forth relative to it by a cam or pitman mechanism. The jaws are farther apart at the top than at the bottom, forming a tapered chute so that the material is crushed progressively smaller and smaller as it travels downward until it is small enough to escape from the bottom opening.

### TYPES OF JAW CRUSHERS

#### Blake jaw crusher

In the Blake or jaw crusher the moveable jaw is pivoted at top. The greatest amount of motion is at the bottom which means it has the little tendency to choke.

#### Dodge jaw crusher

In the dodge jaw crusher the moving jaw is pivoted at the bottom. As minimum movement is at the bottom it has a greater tendency to choke.

### Working

This jaw crusher uses motor as its power. Through the motor's wheels, the eccentric shaft is driven by the triangle belt and slot wheel to make the movable jaw plate move by a regulated track. Therefore, the materials in the crushing cavity composed of fixed jaw plate, movable jaw plate and side-lee board can be crushed and discharged through the discharging opening.

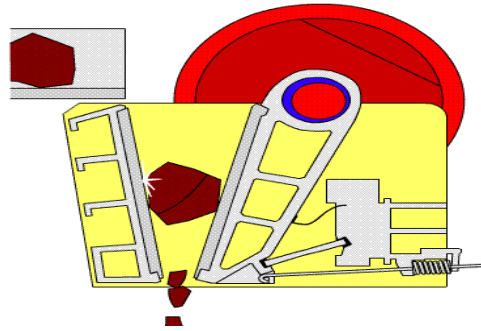

### Applications

- Jaw Crusher can be used in mining, metallurgical industry, construction, road and railway building, chemistry etc.
- Simple structure easy maintenance.
- Stable performance.
- Even final particles and high crushing ratio.

### FLUID ENERGY MILL

Fluid energy mill is also known as pulverizers. It is used for fine grinding and close particle size control. The reduction of the particles takes place by the attrition and impact mechanism by the introduction of the air or inert gas through the nozzles.

The fluid energy mill mainly used to grind the sensitive materials to the fine powder by the mechanism of impact and attrition forces applied by the air or inert gas from the nozzles presents in the chamber.

The main basic parts present in the fluidized energy mill are as follows

- The inlet by which the solid material is introduced into the chamber which is made of stainless steel.
- The nozzles by which the air and the inert gas is introduced into the chamber at high pressure.
- The classifier from which the fine reduced particles are collected.

It consists of a loop of pipe which has a diameter of 20 to 200 mm, depending on the overall height of the loop, which may be up to about 2 m. There is an inlet for the feed and a series of

nozzles for the inlet of air or an inert gas. It also has an outlet with a classifier which allows the air to escape but prevents to pass until they become sufficiently fine.

### Principle

It works mainly on the principle of attrition and impact.

### Working

In the operation of a fluid energy mill, gas of high energy content is introduced into a pulverizing chamber. The air or inert gas is introduced with a very high pressure through the nozzle. Solids are introduced into air stream through the inlet. Due to the high degree of turbulence, impact and attritional forces occurs between the particles. The fine particles are collected through a classifier. Fluid energy mill reduce the particles to 1 to 20 micron. To get a very fine powder even up to 5 micron the material is pretreated to reduce the particle size to the order of 100 mesh and then passed through fluid energy mill. A size-reduction unit depending for its action on collisions between the particles, the energy being supplied by a compressed fluid, (e.g., air or steam) that enters the grinding chamber at high speed. Such mills will give a product of 5 micron or less.

### Applications

- Pulverizers are commonly used for chemicals, pigments and food processing.
- The micro scale air impact pulverizer is used in laboratories, where small samples are needed. Fluid energy mills are used because of their advantages in fine grinding.
- The mill is used to grind heat sensitive material to fine powder.
- 

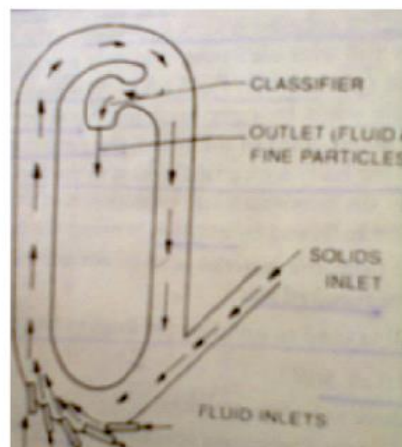

- They have been used for the fine grinding of frits, kaolin, zircon, titanium and calcium, alumina, but the energy consumed per ton of milled product is high. It is also an object to provide grinding of dry solids.
- The mill is used to grind those drugs in which high degree of purity is required.

### Angle of Nip for a roll crushers

Particle just caught hold between the two rolls.

Angle of nip is the angle between the two roll faces at the level where they just take hold of the particle and draw into the crushing zone.

Let the radius of the roll and particle be 'R' and 'r' .

Let '2d' be the gap or clearance between two rolls.

Let the line AB pass through the centre of the L.H.E and the particle through point C. which is the point of contact between the particle and roll. It makes an angle ' $\alpha$ ' horizontal a tangent 'OE' at point 'C' makes the same angle ' $\alpha$ ' with the vertical.

Neglecting gravitational force two forces acts at the point 'C'.

1)  $F_r$  is the radial frictional force having vertical component  $F_r \sin \alpha$

2) The tangential frictional force,  $f_t$  having vertical component  $f_t \cos \alpha$

$f_t$  is related to  $f_r$  by coefficient of friction ' $\mu$ '

$$f_t = \mu f_r$$

$f_r \sin \alpha$  Component pushes the particle outside the rolls .

$f_t \cos \alpha$  Component pulls the particle inside the rolls for crushing

The material said to be crushed when

$$\mu f_r \cos \alpha < f_r \sin \alpha \quad \text{or} \quad \mu f_r \cos \alpha = f_r \sin \alpha$$

$$\mu = \tan \alpha, \alpha \text{ is } \frac{1}{2} \text{ the angle of nip between the rolls}$$

$$\cos \alpha = OA/AB = R+d/r+R$$

All the relations should be used to estimate angle of nip ' $\alpha$ '. Largest product diameter in '2d'.

### Unit – III

#### SEDIMENTATION

The separation of dilute slurry by gravity settling into a clear fluid and slurry of higher solid content is called sedimentation.

#### Batch sedimentation test

Theories of sedimentation

- Coe and Clevenger theory
- Kynch theory

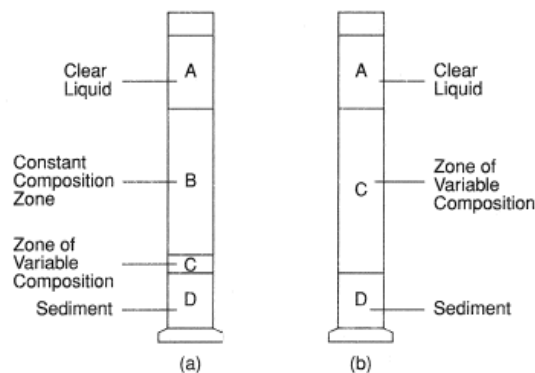

**Figure** Line settling (a), and clarification (b), behavior during sedimentation.

#### Coe and Clevenger theory

Conditions:

- Solid material in the feed (slurry).
- Size of the solid.
- Frequency distribution of the solid particle
- Liquid property remains constant
- Settling rate was a function of solids concentration

**Kynch theory****Limiting layer**

Thickener design is based upon identifying the concentration of the layer having the lowest capacity for the passage of solids thoroughly under operation conditions which is called limiting layer.

This method is based on mathematical analysis of batch settling test presented by kynch, which showed that, the settling rate( $V_L$ ), concentration of the zone, that limits the capacity( $C_L$ ) can be determined by a single batch sedimentation test.

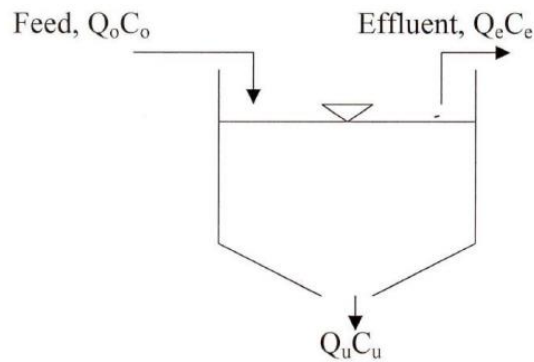

It has been shown the rate of such upward propagation of such a zone is constant is a function of solids

$$\bar{V} = C \frac{dv}{dc} - V \quad \text{--- 1}$$

$\bar{V}$  - Upward propagation velocity in the concentration zone having minimum settling rate with respect to the vessel.

$V$ - Settling velocity of solids having minimum settling rate with respect to vessel.

$C$ - Concentration of solids.

From Coe and Clevenger theory, settling rate is a function of solids concentration only

$$V = f(c) \quad \text{--- 2}$$

$$\frac{dv}{dc} = f'(c) \quad \text{--- 3}$$



Substitute 2 and 3 in 1

$$\bar{V} = c \int f(c) - f(c) \quad \text{_____ 4}$$

Let  $C_0$  and  $Z_0$  be the initial concentration and initial height of solids of the batch settling test respectively

$$\text{Total height of solids in the slurry} = C_0 Z_0 A \quad \text{_____ 5}$$

Where  $A$  – cross sectional area of slurry column

Assume the test reaches the limiting layer ( $C_L$ ), then the concentration of layer and the time taken is  $\theta_L$ , then the weight of solids at that layer is given by

$$= C_L A (V_L - \bar{V}_L) \theta_L \quad \text{_____ 6}$$

Where  $V_L$  and  $\bar{V}_L$  are respective velocities for the layer having a solid concentration of  $C_L$ . Let  $Z_L$  corresponds to the height of interface at  $\theta_L$ , then

$$\bar{V}_L = \frac{Z_L}{\theta_L} \quad \text{_____ 7}$$

Substitute 7 in 6

$$\begin{aligned} \text{Weight of solids in the limiting layer} &= C_L A (V_L - \frac{Z_L}{\theta_L}) \theta_L \\ &= C_L A (V_L \theta_L - Z_L) \quad \text{_____ 8} \end{aligned}$$

Equating 5 and 8

$$\begin{aligned} C_0 Z_0 A &= C_L A (V_L \theta_L - Z_L) \\ C_L &= \frac{C_0 Z_0}{(V_L \theta_L - Z_L)} \quad \text{_____ 9} \end{aligned}$$

To estimate the settling rate  $V_L$  a graph of height of interface  $Z$  Vs time taken to the interface. The tangent intercepts the radial axis at  $Z=Z_i$  the point for which the tangent is drawn corresponds to  $Z_L$  and  $\theta_L$ , then the settling rate is given by

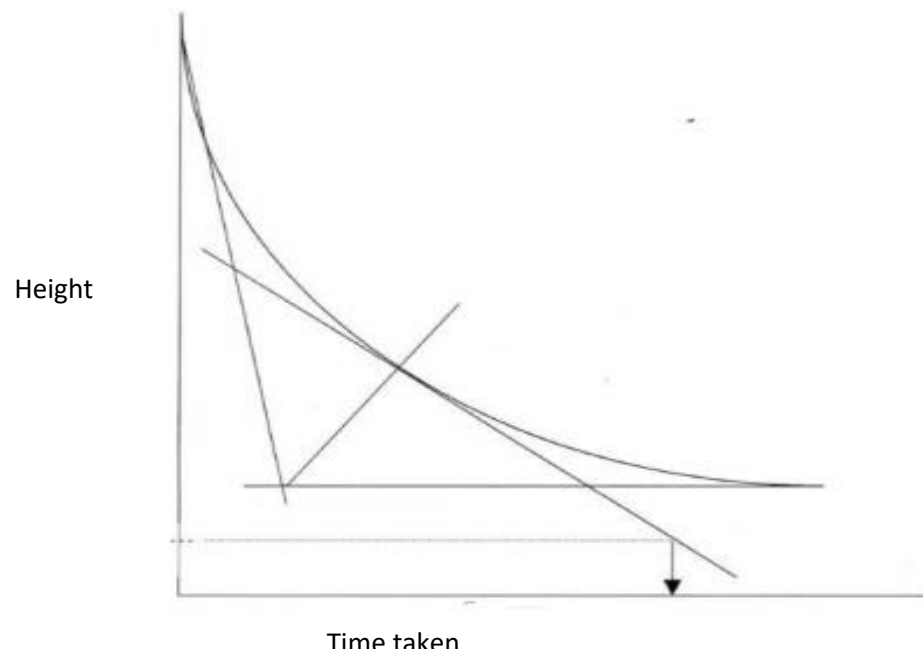

$$V_L = \frac{Z_L - Z_i}{\theta_L}$$

$$V_L \theta_L = Z_L - Z_i$$

$$Z_i = V_L \theta_L + Z_L \quad \text{-----} \quad 10$$

Substitute 10 in 9

$$C_L = \frac{C_0 Z_0}{Z_i}$$

### MECHANICAL SEPARATIONS

Motion of particles through fluids

When a particles is moving through a fluid three types of forces will be acting on it

- The external force ( $F_e$ ), it may be gravitational force or centrifugal force.
- Buoyancy force ( $F_b$ ) which acts parallel to the external force but opposite in direction
- Drag force ( $F_D$ ) which appears when there is a relative motion between the solid and fluid

Resultant force is given by  $= F_e - F_b - F_D$  \_\_\_\_\_ 1

The Resultant force is the given in terms of momentum to the particle and the particle moves down with an acceleration  $du/dt$

$$m \frac{du}{dt} = F_e - F_b - F_D$$
 \_\_\_\_\_ 2

The external force ( $F_e$ ) can be given as a product of mass and acceleration of the particle

$$F_e = ma_e$$
 \_\_\_\_\_ 3

The buoyancy force ( $F_b$ ) is equal to the product of mass of liquid displaced due to particle settling and acceleration due to gravity

$$F_b = \frac{m}{\rho_P} \rho a_g$$
 \_\_\_\_\_ 4

$\rho_P$  = density of particle

$\rho$  = density of water

The drag force is given by

$$F_D = \frac{C_D u^2 \rho A_P}{2}$$
 \_\_\_\_\_ 5

Substitute 3, 4, and 5 in 2

$$m \frac{du}{dt} = ma_e - \frac{m}{\rho_P} \rho a_g - \frac{C_D u^2 \rho A_P}{2}$$

put  $a_e = g$

$$\frac{du}{dt} = \left( \frac{\rho_P - \rho}{\rho_P} \right) g - \frac{C_D u^2 \rho A_P}{2m}$$
 \_\_\_\_\_ 6

Equation 6 is called the motion of particles through fluids

### Settling velocity or terminal settling velocity

Gravitational settling  $g$  is constant, the drag always increases with the velocity according to equation 6, the acceleration decreases with time and approaches to zero. The particle quickly reaches a constant velocity which is the maximum attainable velocity under this condition is called terminal velocity or settling velocity or terminal settling velocity

When  $du/dt = 0$  and  $u = u_t$

$$\frac{du}{dt} = \left(\frac{\rho_p - \rho}{\rho_p}\right)g - \frac{C_D u^2 \rho A_p}{2m} \quad \text{-----} \quad 6$$

$$0 = \left(\frac{\rho_p - \rho}{\rho_p}\right)g - \frac{C_D u_t^2 \rho A_p}{2m} \quad \text{-----} \quad 6$$

$$u_t = \sqrt{\frac{(\rho_p - \rho)2mg}{\rho_p A_p C_D \rho}} \quad \text{-----} \quad 7$$

Equation 7 is called as terminal settling velocity

### **Free settling:**

when the particles is at sufficient distance from the boundary of the container and from other particles, so that its fall is not affected by them, then such a process is called free settling.

### **Hindered settling:**

If the motion of the particle is affected by other particle which will happen when the particles are nearer to each other they may not be actually colliding. This type of process is called as Hindered settling.

### Motion of spherical particles under free settling

We know that for a spherical particles of  $m$

$$m = V_p \rho_p = \frac{\pi D_p^3 \rho_p}{6}$$

$$A_p = \frac{\pi D_p^2}{4}$$

Substitute in 7

$$u_t = \sqrt{\frac{(\rho_p - \rho) D_p g}{3 C_D \rho}} \quad \text{8}$$

For particles moving with constant velocity under force the Drag coefficient is related to particle Reynolds number ( $R_{ep}$ )

$$C_D = \frac{b_1}{(R_{ep})^n}$$

When  $b_1$  and  $n$  are constants the values of  $b_1$  and  $n$  depends upon various range of settling

$$C_D = \frac{b_1}{\left(\frac{D_p u_t \rho}{\mu}\right)^n} \quad \text{9}$$

Substitute 9 in 8

$$U_t = \left(\frac{4(\rho_p - \rho) g D_p^{n+1}}{3 b_1 \mu^n \rho^{1-n}}\right)^{\frac{1}{2-n}} \quad \text{10}$$

Equation 10 is called the general equation for terminal settling velocity in terms of diameter of particles and properties of solids and fluids.

Range of settling	$b_1$	$N$	$R_{ep}$
Stokes Range	24	1	0-1
Intermediate range	18.5	0.6	1-1000
Newton's range	0.44	0	>1000

For stoke's range  $b_1=24$  and  $n=1$

Substitute in 10

$$U_t = \left(\frac{(\rho_p - \rho) g D_p^3}{18 \mu}\right) \quad \text{11}$$

The above is the terminal settling velocity for stokes range

For intermediate range  $b_1=18.5$  and  $n=0.6$

substitute in 10

$$U_t = \left(\frac{0.154 (\rho_p - \rho)^{0.71} g D_p^{1.14}}{\mu^{0.43} \rho^{0.29}}\right) \quad \text{12}$$

For Newton's range  $b_1=0.44$  and  $n=0$

$$U_t = 1.74 \left( \frac{(\rho_p - \rho) g D_p}{\rho} \right)^{1/2}$$

### Criterion equation for settling

If terminal settling velocity of a particle of known diameter and Reynolds number is unknown choice of equation (Stokes, Intermediate and Newton's) cannot be made.

We know that

$$Re_p = \frac{D_p u_t \rho}{\mu} \quad \text{-----} \quad 1$$

For Stokes range  $u_t = \left( \frac{(\rho_p - \rho) g D_p^2}{18 \mu} \right) \quad \text{-----} \quad 2$

Substitute 2 in 1

$$Re_p = \frac{(\rho_p - \rho) g D_p^3 \rho}{18 \mu^2} \quad \text{-----} \quad 3$$

$$K = D_p \left( \frac{(\rho_p - \rho) g}{\mu^2} \right)^{1/3}$$

$$Re_p = \frac{K^3}{18}$$

$K = 2.62$  for particles lies in Stokes range

$K = 68.89$  for particles lies in Newton's range

$K = 2.62$  and  $68.89$  for particles in intermediate range.

### SEDIMENTATION

The separation of solids from a suspension in a liquid by gravity settling is called sedimentation. In this process, dilute slurry is separated into a clear liquid and slurry of higher solid content. The dorr thickener is a common piece of equipment used for sedimentation.

Sedimentation is one of the most widely used processes in the treatment of water. The simplest method of removing the suspended impurities is by plain sedimentation. The water is allowed to stand quiescent or move very slowly through basin until the suspended impurities settle to the bottom and relatively clear water is drawn off from the top. The degree of removal of suspended

impurities depends upon the length of retention period, the size of the suspended impurities and the temperature of water.

Free settling refers to the process wherein the fall of the particle in a gravitational field through a stationary fluid is not affected by the walls of container and other particles. This necessitate that the particles be at sufficient distance from the wall of container and also from each other. Partially, the free settling conditions exist if the concentration of the particles in suspension is less than 1% wt. by solids. In such cases as the particle falls its velocity increases and will continue to increase until the resisting force and accelerating force (force of gravity) are equal. When this point is reached, the particles will settle at a definite constant velocity during remainder of its fall. This ultimate constant velocity is called terminal settling / falling velocity.

When the concentration of particles in suspension is large, particles will be so close to each other that the surrounding particle will interfere with the motion of other individual particles. If the fall of particle through stationary fluid is impeded by the other particles (as is the case when particles are near to each other), the process is called hindered settling. For hindered flow, the settling is considered less than terminal falling velocity under free setting condition. Hindered settling is encountered in sedimentation. In this case, particle is settling through suspension of particles in fluid rather than through fluid itself.

### BATCH SEDIMENTATION TEST

The mechanism of settling may be best described by batch settling test in a glass cylinder. Fig. shows a cylinder containing newly prepared slurry of a uniform concentration of uniform solid particles throughout. As soon as the process starts, all the particles begin to settle and are believed to approach rapidly terminal settling velocities under hindered settling conditions. Various zones of concentration then are established as shown in figure. The heavier faster settling particles settled at the bottom of a glass cylinder are indicated by zone D. Above zone D forms another layer called zone C, a region of variable size distribution and non uniform concentration. The boundary between C and D is usually obscure and is marked by vertical channels through which fluid is rising from the lower zone D as it compresses. Above zone C is zone B, which is a zone of uniform concentration, of approximately, the same concentration as that of the original pulp (suspension of solids is referred to as pulp in metallurgical work.) above zone B is zone A, which is a zone of clear liquid. If the original slurry is closely sized with respect to the smallest particles, the boundary between A and B is sharp.

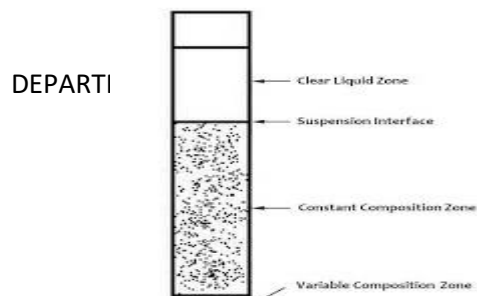

JG

SATHYABAMA INSTITUTE OF SCIENCE AND TECHNOLOGY

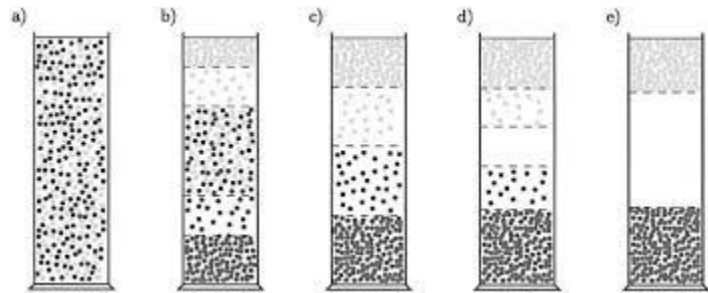

As sedimentation continues, the heights of each zone vary as shown in the fig. The heights of zone D and A increase at the expense of that of zone B while that of C remains constant. After further settling zones B and C disappear, all the solids appear in zone D, but zone D may shrink further because of compression. During compression, the liquid associated with the solids in zone D is expelled in a clear zone.

In a batch sedimentation operation as discussed, depths (heights) of the various zones vary with time. The same zones will be present in a continuous thickener, but in a continuous sedimentation process, once the steady state is set up the heights of each zone will be constant. Fig shows how the zones of fig may be arranged in continuously operating equipment such as a thickener.

In a batch settling test carried out in a laboratory, the height of the liquid–solid interface (between zones A and B) is measured as a function of time. When the experimental data of height of interface  $v/s$  time are plotted, we get the curves as shown in fig. The slope of this curve at any point of time represents the settling velocity of suspension at that instant. During the early stage of the settling process, the rate of settling is constant, as shown by the first portion of the curve. As time increases, the settling velocity decreases and steadily drops until the ultimate height is reached. The batch settling test will give a different curve for every sludge and somewhat different one for different concentrations. Such batch tests are the basis for the design of a continuous thickener.

### THICKENER:

In industrial sedimentation operations, they may be carried out batch wise or continuously in equipment called a thickener. A thickener consists of a relatively shallow tank from the top of which clear liquid is taken off and the thickened liquid is taken off and the thickened liquid is withdrawn / removed from the bottom. In majority cases, the concentration of the suspension is high and hindered settling takes place. The rate of sedimentation can be artificially increased by the addition of coagulating agents such as alum etc. This causes the precipitation of colloidal particles and the formulation of flocks. The suspension is also frequently heated which causes a reduction in the viscosity of the liquid. Further, the thickener is frequently provided with a slow

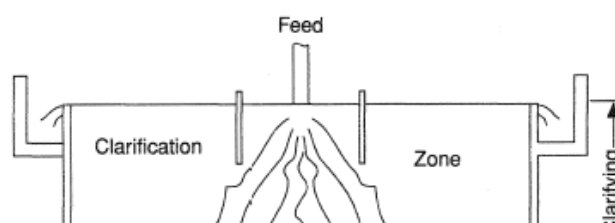



stirrer which helps in the consolidation of the sediment and also reduces the apparent viscosity of the suspension.

A batch thickener usually consists of a cylindrical tank provided with openings for a slurry feed and product discharge. The bottom of the cylindrical tank is conical. The tank is filled with dilute slurry, and the slurry is allowed to settle. After the sedimentation has proceeded for an adequate time, clear liquid is decanted until sludge appears in the draw off and thickened liquid (sludge) is withdrawn from the bottom openings as indicated in fig.

A continuous thickener, such as the Dorr thickener consists of a flat bottomed, large diameter shallow – depth tank. It is provided with slow moving radial rakes driven from a central shaft for removing the sludge. The slurry is used as the centre of tank at a depth of 0.3 m to 1 m below the surface of the liquid, with as little disturbance as possible. The clarified liquid is continuously removed from an overflow which runs around the top edge of the tank a launder and the thickened liquor is continuously withdrawn from the outlet at the bottom. The slowly revolving rakes serve to scrape the sludge towards centre of the bottom for discharge and to remove water from the sludge as it stirs only the sludge layer. Thus, the solids are continuously moving downwards and then inwards to the sludge outlet; the liquid is moving upwards, and then rapidly outwards.

The two functions of the thickeners are:

1. To produce clear liquid and
2. To produce a given degree of thickening of the suspension.

The upward velocity of the liquid must, all the times, is less than the settling velocity of particles for production of clarified liquid. Thus, for a given throughput, the diameter of the tank determines the clarifying capacity of the thickener

### **Gravity settling tank**

It is the simplest type of classifier. It consists of a large tank with provisions for a suitable inlet and outlet. A slurry feed enters the tank through an inlet connection. As soon as the slurry feed enters the tank, its linear velocity decreases as a result of the enlargement of cross sectional area. Solid particles start to settle under the influence of gravity. The faster settling particles (coarse particles) will be collected at the bottom of the tank near the inlet/entrance, while the slower settling particles (small particles) will be carried farther into the tank before they reach the bottom of the tank / the very fine particles are carried away in the liquid overflow from the tank. Vertical baffles placed at various distances from the inlet within the tank allow for the collection of several fractions (different grades of particles) according to the terminal falling velocities. Because of occurrence of considerable overlapping of size, no sharp separation is possible with this classifier.

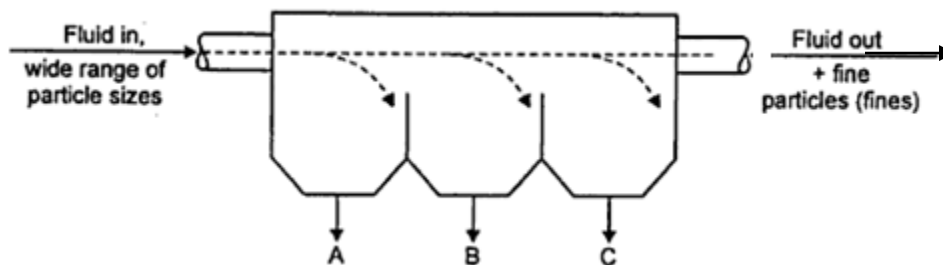

Figure: Gravity settling tank

### **Cone classifier:**

A cone classifier is simply a cone (conical vessel) installed point down, with a discharge launder around the top (of the cone). The feed is introduced in the form of a suspension through a feed inlet provided at the center at the top. The coarse fraction (the partially drained fraction containing the coarse material) collects at the point of the cone (i.e., at the apex) and is withdrawn periodically or continuously. The fine fraction along with the remaining portion of the liquid is removed from the launder as an overflow. The separation achieved with their unit is

only an approximate one. Cone classifiers, though one of the oldest types, are still used for relatively crude work because of low cost of installation. They are used in ore dressing plants.

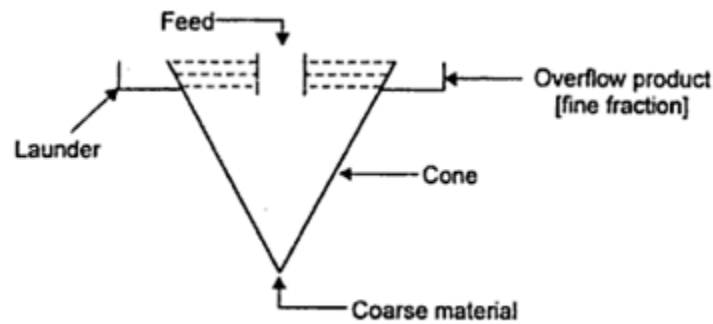

Figure: Cone classifier

### Double cone classifier:

This classifier uses hydraulic water for classification (a stream of additional water supplied to classifier is called hydraulic water).

The double cone classifier is shown in figure. It consists of a conical vessel inside of which is second hollow cone. The inner cone is slightly larger in angle, arranged apex downwards and is movable in vertical direction. The bottom portion of the inner cone is cut away and its position (height) relative to the outer cone is regulated by a screw adjustment.

The feed to be separated is fed in the form of a suspension to the center of the inner cone. It flows downward through the inner cone and out at a baffle at the bottom of the inner cone. Hydraulic water is fed near the outlet for the coarse material. The solids from the inner cone and a rising stream of water are mixed below the inner cone and their flow through an annular space between the two cones, classification action occurs in the annular space, the small/fine particles are carried away in the overflow while the large particles/ coarse particles settle against the hydraulic water to the bottom and are removed periodically.

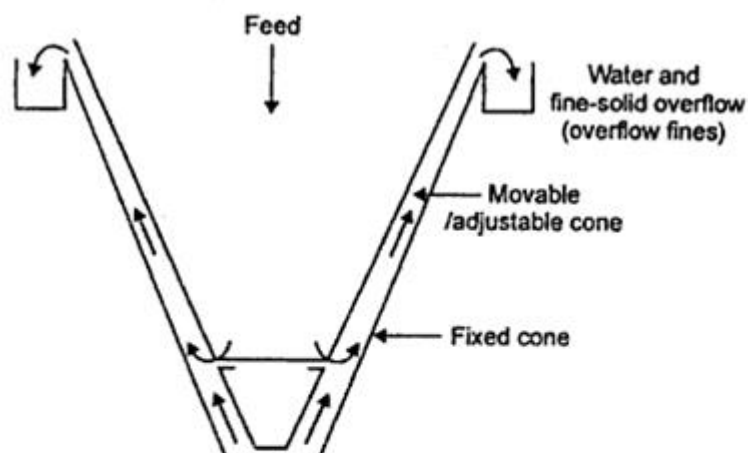

Figure: Double cone classifier

**Mechanical classifiers:**

Rake classifier: The rake classifier such as the Dorr classifier consists of a rectangular tank with a sloping/inclined bottom. The tank is provided with movable rakes (reciprocating rakes). The feed in the form of a suspension (slurry) is introduced continuously near the middle of the tank. The lower end of the tank has a weir overflow (discharge weir) from which the fines that are not settle leave with the overflow liquid. The heavy material (coarser particles) sinks to the bottom of the tank. The rakes scrap the settled solids upward along the reciprocating rakes keep the slurry in continuous agitation. The time of raking stroke is so adjusted that fines do not have time to settle and so remain near the surface of the slurry, while the heavy particles have time to settle [they settle, scrapped upward and removed as a dense slurry (called the sand)].

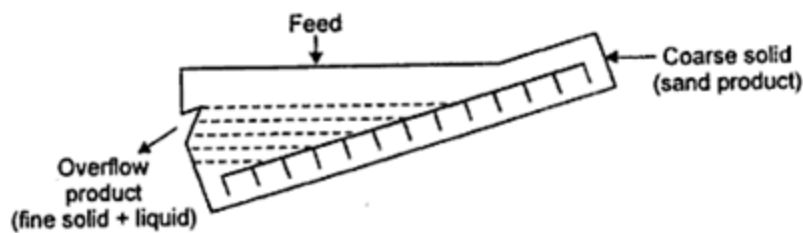

Figure: Rake classifier

**Spiral classifier:**

Another mechanical classifier is the spiral classifier. The spiral classifier such as the Akins classifier consists of a semi cylindrical trough (a trough which is semicircular in cross section) inclined to the horizontal. The trough is provided with a slow rotating spiral conveyor and a liquid overflow at the lower end. The spiral conveyor moves the solids which settle to the bottom upward toward the top of the trough.

Slurry is fed continuously near the middle of the trough. The slurry feed rate is so adjusted that fines do not have time to settle and are carried out with the overflow liquid. Heavy particles have time to settle, they settle to the bottom of the trough and the spiral conveyor moves the settled solids upward along the floor of the trough toward the top of the trough/the sand product discharge chute.

Rake and spiral classifiers are used for close circuit grinding.

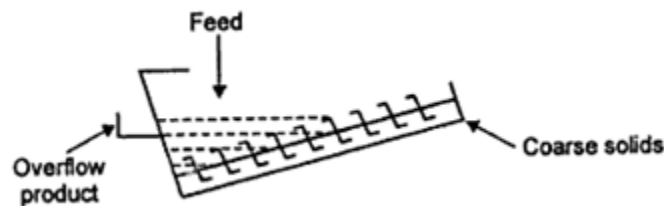

Figure: Spiral classifier

### Cyclones/ Cyclone separators:

A cyclone separator is essentially a settling chamber in which the gravitational separation force is replaced by a much stronger centrifugal separating force (to increase the settling rate).

Cyclone separators are used for the separation of solids from fluids. They offer one of the least expensive means of dust collection (separation of dust particles from gases) from both an operating and an investment view point. They utilize centrifugal force to affect the separation which depends on particles size and /or on particle density. Thus, cyclones are used to effect a separation on the basis of particle size or particle density or both.

It consist of a tapering cylindrical vessel i.e., a cylindrical vessel consisting of a top vertical section and lower conical/tapering section termination in an apex opening a short vertical cylinder which is closed by flat plate on top and by conical bottom. It is provided with a tangential feed inlet nozzle in the cylindrical section near the top and an outlet for the gas, centrally on the top. The outlet is provided with a downward extending pipe, a pipe that extends

inward into the cylindrical section to prevent the gas short circuiting directly from the inlet to the outlet and for cutting the vortex.

In this separator, used for the separation of dust particle or mist from gases, the dust laden gas introduces tangentially into a cylindrical vessel at a high velocity (30m/s). Centrifugal force throws the solid particles out against the wall of the vessel and they drop into a conical section of the cyclone and removed from the bottom/apex opening. The clean gas is taken out through a central outlet at the top.

Cyclones are widely used for collecting heavy and coarse dusts. These units may also be used for separation coarse materials from fine dust.

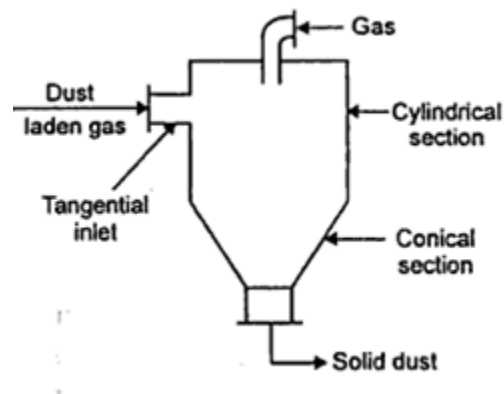

Figure: Cyclones/ Cyclone separators

### **Liquid cyclones (hydrocyclones)**

Cyclone separators may also be used to effect the classification of solid particles suspended in a liquid. In such cases, the commonly used liquid is water.

Liquid cyclone has a top cylindrical section and a lower conical section termination in an apex opening. The top vertical section is covered by a flat plate and is provided with a tangential inlet at the top. The cover has a downward extending pipe to cut the vortex and remove the overflow product since the viscosity of water is much higher than that of a gas, the fluid resistance encountered in the cyclone is greater than that in the cyclone used for dust collection. Therefore, the diameter of this cyclone must be smaller in order to get a corresponding greater/larger centrifugal force. Consequently, the diameter of cylindrical section is less than 375mm and the

cone angles are  $15^{\circ}$  to  $20^{\circ}$ . Inlet pressures of the feed (induced by means of a pump) to the cyclone lie between 5 to 120 psi.

The slurry feed is pumped into the cylindrical section tangentially. Coarse or heavy solids thrown out against the walls, travel down the sides of cone section and are discharged in a partially dewatered form from the apex, while the smaller or lighter solids along with the remaining portion of water are removed from the downward extending pipe at the top. Liquid cyclones find application in degrading operation in alumina production, classifying pigments and ore dressing practice.

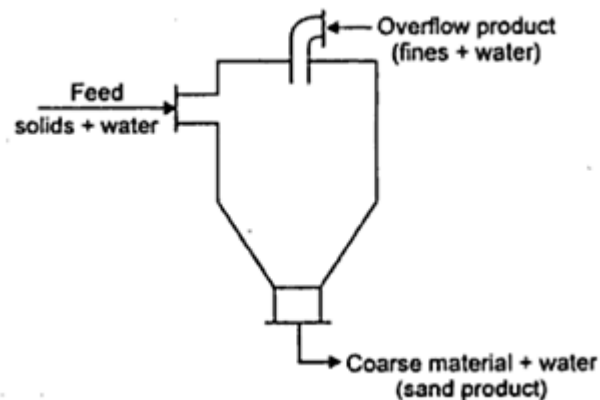

Figure: Liquid cyclones (hydrocyclones)

### Jigging:

A jig is a mechanical device used for the separation of materials of different specific gravity by pulsating a stream of liquid (usually water) flowing through a bed of materials resting on a screen.

Jigging is a method of separating materials of different specific gravities by the pulsation of a stream of liquid (water) flowing through a bed of materials resting on a screen.

Pulsate  $\Rightarrow$  oscillate  $\Rightarrow$  move or swing back and forth at a regular rate

Jig  $\Rightarrow$  move up and down with a quick jerky motion.

### Principle of operation:

Jigging is a process of gravity concentration where solids are separated based on the differences in behaviour of particles through a moving fluid which in turn, depends upon densities or specific gravities. Separation of solids of different specific gravities is achieved by the pulsation

of a liquid stream flowing through a bed of solids on a screen. The liquid pulsates or jigs up and down and this action causes the heavy material to move towards the bottom of the bed and the lighter material to rise to the top. Each product is taken out separately.

#### Applications:

Jigging is used for concentrating heavy minerals from the light minerals. It is commonly employed for coarse material having a size 20 mesh and above and where there is a sizeable/fairly large difference between the effective specific gravity (effective  $SG = S.G$  of mineral –  $S.G$  of water) of the valuable and the waste material.

Jigs are simple in operation, consume very large quantities of water and have high tailings losses on metallic ores. They are used mostly to treat iron ores, few lead zinc ores, etc. jigging is widely used for the concentration of coal.

#### Hydraulic jig:

It operates by providing very short periods for material to settle due to which the particles do not attain their terminal falling velocities and initial velocities cause the separation. Thus, it is suitable for the separation of materials of wide size range into their constituents.

#### Construction:

The hydraulic jig is shown in figure. It consists of a rectangular section tank with a tapered bottom. The tank is divided into two portions/compartments by a vertical baffle. In one compartment, a plunger is incorporated. It is operated in a vertical direction giving a pulsating motion to the liquid. In the other compartment, a screen is incorporated. The separation of material is carried out over this screen. It is provided with a connection for feeding liquid during the upstroke. It is also provided with a bottom discharge connection for the removal of small particles of heavy material and gates at the side of jig for the removal of particles settled on the screen and for overflow.

#### Working:

The material to be separated is fed over a screen and is subjected to a pulsating action by oscillating liquid with the help of a reciprocating plunger. During the upward stroke of the plunger, input water is taken into the jig and there is no net flow through the bed of solids. During the downward stroke, water inlets is closed and on the screen are brought into suspension and they segregate according to their size and density such that the dense material is collected near the bottom of screen. Very small particles of the dense material will pass through the screen



and are collected at the bottom of the jig. Small particles of the less dense material (light material) carried by the liquid water are removed through an overflow. The material retained on the screen is removed through gates provided at the side.

Four fractions obtained from the jig are:

1. Small and dense material passing through the screen collected at the bottom of the tank.
2. Small size less dense material in the liquid overflow.
3. Large size dense material segregated near a screen removed through a gate at the side.
4. Large size dense material segregated above the dense material removed through a gate at the side

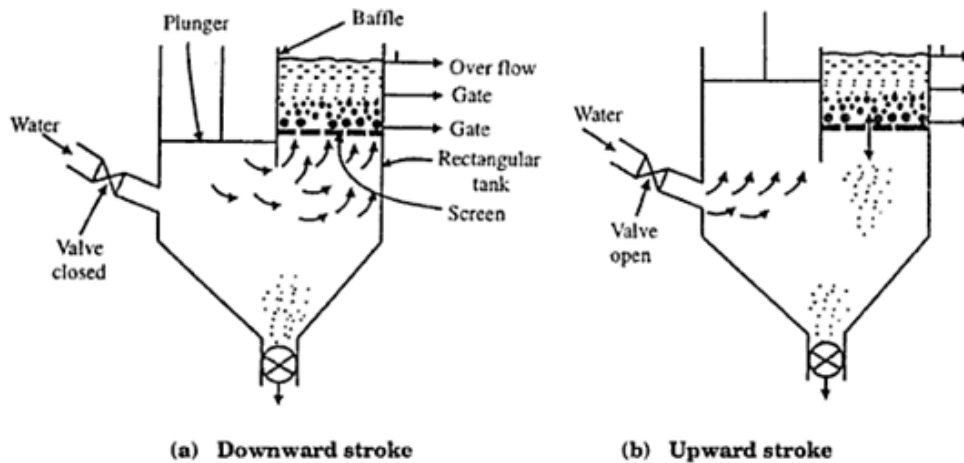

Figure: Hydraulic jig

Four fractions obtained from the jig are:

5. Small and dense material passing through the screen collected at the bottom of the tank.
6. Small size less dense material in the liquid overflow.
7. Large size dense material segregated near a screen removed through a gate at the side.
8. Large size dense material segregated above the dense material removed through a gate at the side

#### Flootation Machine / floatation cell:

The mechanically agitated cell consists of a tank having square or circular cross section. It is provided with an agitator which violently agitates the pulp. The air from a compressor/blower is introduced into the system through a downpipe surrounding the impeller shaft. The bottom of

the tank is conical and is provided with a discharge for tailings. An overflow is provided at the top for mineralized froth removal.

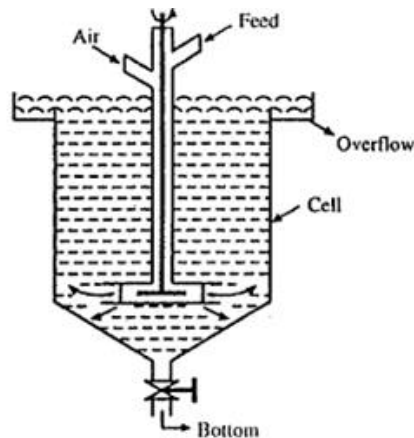
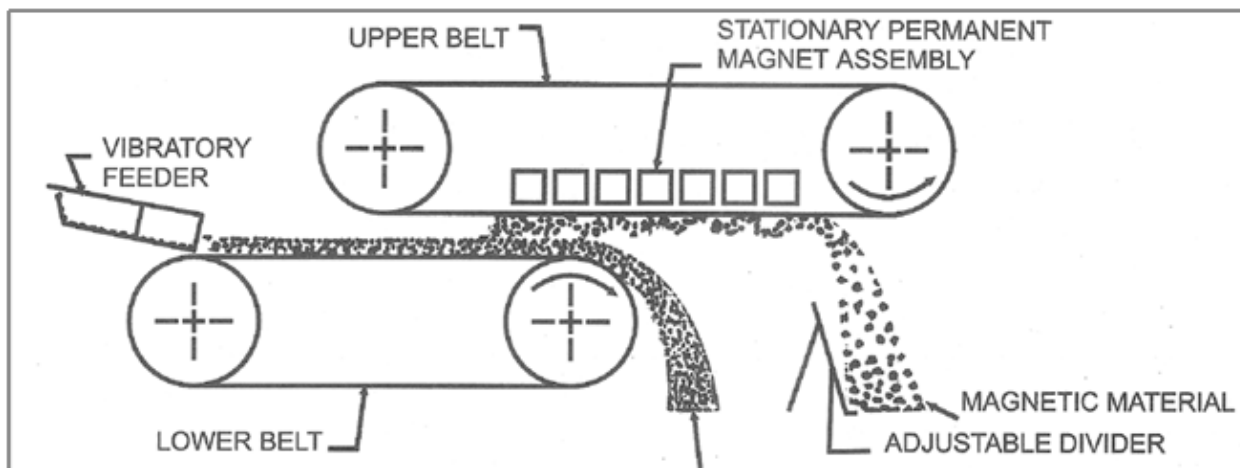

Figure: Froth floatation cell

**Working:** Water is taken into the cell; material is fed to the cell. The promoters and frothers are added. Agitations are given and air is bubbled in the form of fine bubbles. Air avid particles due to reduction in their effective density will rise to the surface and be held in the froth before they are discharged from the overflow. Hydrophilic particles will sink to the bottom and removed from the discharge for tailings.

### Magnetic separation

- Materials that have different magnet attract ability may be separated by passing them through a magnetic field.
- Used to remove iron, steel and iron oxide from materials
- Electromagnet is used as a pulley which is under a conveyor belt.
- To remove magnetic material from slurry and also Fe from waste stream.



### Electrostatic precipitation

- Capable of collecting very fine particles  $< 2$  micro meter
- Considered as an alternating process such as filtration, where gases of hot and corrosive.
- ESP is used mainly in metallurgical, cement and electrical power industries.
- Main application removal of fined fly ash formed in combustion of pulverised coal in power station boilers.

#### Principle:-

- Gas ionised in passing between a high voltage electrode and an earthened electrode
- Dust particle become charged and are attracted to the earthened electrode.

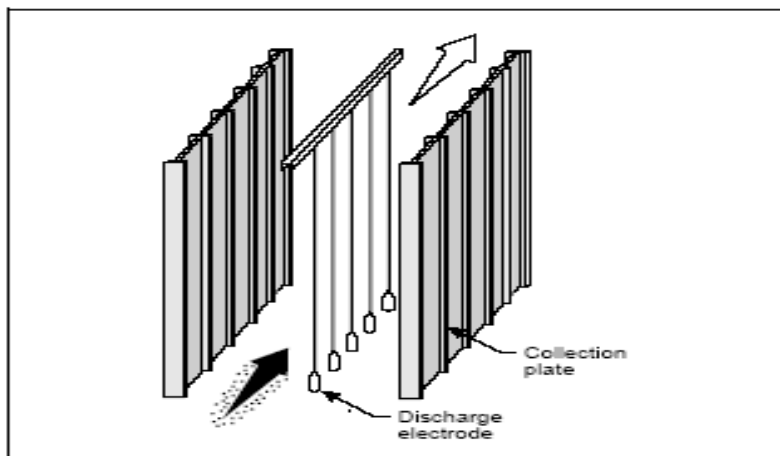

- The precipitate dust is removed from the electrode mechanically by vibration or by washing.
- Wires are normally used for high voltage electrode . Plates or tubes for earthened electrode.
- Gas is passed between two electrodes charge to a potential difference of 10-60 kV. It is subjected to action of corona discharge.
- Most industrial gases are sufficiently conducting to be readily ionized. Most important conducting gases are  $\text{CO}_2$ ,  $\text{CO}$ ,  $\text{SO}_2$ , and  $\text{H}_2\text{O}$  vapour.
- Gas velocity varies from 0.6 to 0.8 m/s, with an average contact time of 0.8 m/s.
- collection efficiency  $\eta = 90\%$  obtained at low gas velocity.
- ESP gas flow-  $50\text{m}^3/\text{s}$ , temperature -800 k
- Pressure drop is low.

UNIT – IVFILTRATION

Filtration is the separation process of solid particles from liquids through a solid support (or) filter medium.

**Mechanism of filtration**

Slurry: The suspension of solid and liquid to be filtered.

Filter medium: The porous medium used to retain the solids.

Filter cake: The accumulation of solids on the filter medium.

Filtrate: The clear liquid passing through the filter and collected in the receptor.

In the early stages of liquid filtration particles are retained on the fibers of filter medium by the following mechanisms:

- (i) Straining, (ii) Impingement, (iii) Entanglement and (iv) Attractive forces

After a preliminary layer of particles are deposited on the filter-medium, the filtration occurs through the filter cake. This time filtration obeys Kozeny's equation.

Straining

The particles larger than the pore size of filter medium will be retained on the latter.

Impingement

When a dilute suspension approaches a fiber the fluid passes along the side of the fiber will pass with the fluid but the particles in between A – B region will hit directly on the fiber. Due to their higher moment of inertia they strike (impinge) on the fiber and accumulate to form a ridge, roughly triangular in section.

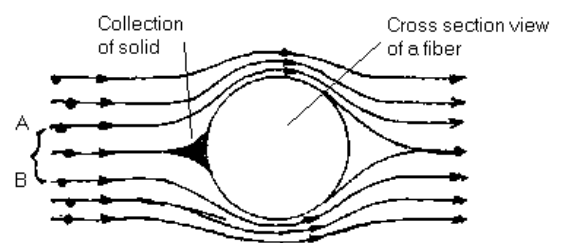
Entanglement

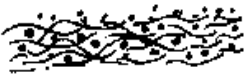

If the filter medium consists of a cloth or is a porous felt, then particles become entangled in the mass of fibers. Usually the particles are smaller than the pores.

### Attractive forces

In some cases, particles may collect on a filter medium as a result of attractive forces. Gas flowing through a filter medium causes generation of charges on the filter surface. The particles containing charge gets attracted to the surface.

### Filter media

Some filter media widely used are heavy cloth, other types of woven heavy cloth, woolen cloth, Glass cloth, paper, felted pad of cellulose, metal cloth, nylon cloth, Dacron cloth and other synthetic cloths.

### FILTER AIDS

If the slurry contains highly compressible materials the cake produced will provide very high resistance to the flow of fluid (i.e. very high specific cake resistance) – so filtration rate will be reduced. Filter –aids are the substances incorporated in the concentration up to 5% to the high resistance cakes to decrease their resistance and increase filtration rate.

### Mechanism of action

Filter aids impart rigidity and porosity to the cake due to their peculiar irregular shape, low surface area and narrow particle size distribution. The rigid structure provides support for the compressible particles in the slurry.

### Agents used as filter aids

Purified talc, keiselghur or diatomaceous earth (pure  $\text{SiO}_2$ ), charcoal, kaolin, asbestos, cellulose and volcano glass (called “Pearlite”).

### APPLICATION METHODS OF FILTER AIDS

The filter aid is used by three methods:

1. *Body mix method*: The filter-aid in the concentration of 0.01 – 4% w/v is mixed with the main slurry to be filtered. The slurry containing the filter aid is then filtered.
2. *Pre-coat method*: If the pressure drop is very high then this method is preferred. A layer of filter-aid up to a suitable thickness is first formed by filtration of filter aid and then slurry is filtered.
3. *Special pre-coat method*: It is used in rotary drum filter. The filter aid slurry is first filtered, while the scrapper-knife is removed. Once the filter-aid cake (pre-coat) of desired thickness is formed the main slurry is filtered. This time scrapper-knife is fitted, it scrapes the cake along with a small thickness of the pre-coat.

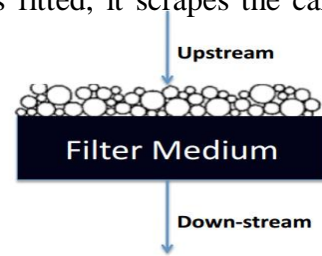

## Theory of filtration

### Pressure drop of fluid through filter cake

From Haegen- Poiseuille's law

$$\frac{-\Delta P_c}{L} = \frac{32\mu V}{D^2} \text{-----} 1$$

From Kozeny – Caramen equation

$$\frac{-\Delta P_c}{L} = \frac{k_1\mu V(1-\varepsilon)^2 S_0^2}{\varepsilon^3} \text{-----} 2$$

Where  $S_0$  = Specific Surface area of the particles

$\varepsilon$  = Void fraction in the cake

$K_1$  = proportionality constant

$V$  = linear velocity

$A$  = filter area

$L$  = Length of cake

$\mu$  = Filtrate Viscosity

$V$  = Filtrate volume

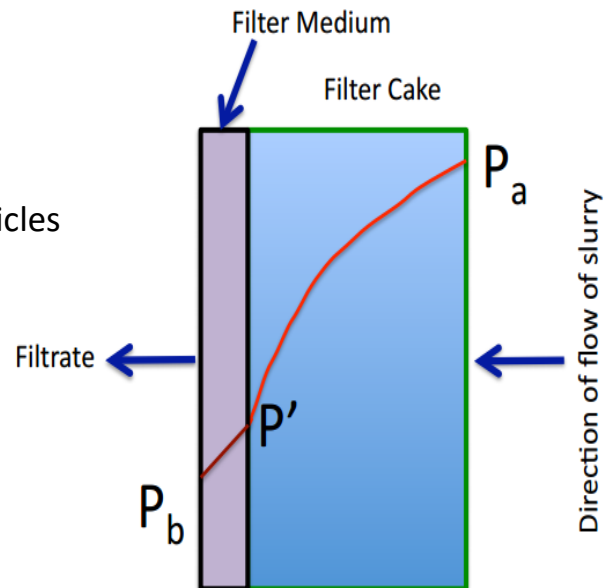

The linear velocity based on empty cross sectional area is given by

$$V = \frac{dv/dt}{A} \quad \text{or} \quad \frac{dv}{A dt} \quad \text{-----} \quad 3$$

From 2

$$V = \frac{-\Delta P_c \varepsilon^3}{LK_1 \mu (1-\varepsilon)^2 S_0^2} \quad \text{-----} \quad 4$$

A material balance equation is given by weight of solids in cake = weight of solids in slurry

$$LA(1-\varepsilon)\rho_p = C_s(V + \varepsilon LA) \quad (\text{volume of the filtrate in cake is usually small})$$

$C_s$  = slurry Concentration

$$L = \frac{C_s V}{A(1-\varepsilon)\rho_p} \quad \text{-----} \quad 5$$

Substitute 3 and 5 in 4

$$\frac{dv}{A dt} = \frac{-\Delta P_c \varepsilon^3}{\frac{C_s K_1 \mu (1-\varepsilon)^2 S_0^2}{A(1-\varepsilon)\rho_p}}$$

$$\frac{dv}{A dt} = \frac{-\Delta P_c}{\frac{K_1 (1-\varepsilon) S_0^2 \mu C_s V}{\varepsilon^3 \rho_p A}} = \frac{-\Delta P_c}{\alpha \mu C_s V} \quad \text{-----} \quad 6$$

$$\text{Where } \alpha = \frac{K_1 (1-\varepsilon) S_0^2}{\varepsilon^3 \rho_p}$$

Filter medium resistance is given by

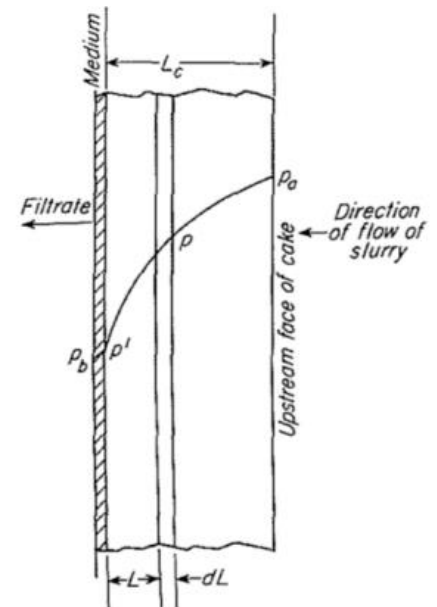



$$\frac{dv}{A dt} = \frac{-\Delta P_f}{\mu R_m} \text{-----} 7$$

The resistance of the cake and filter medium is related by

$$\frac{dv}{A dt} = \frac{-\Delta P_c}{\frac{\alpha \mu C_s V}{A}} + \frac{-\Delta P_f}{\mu R_m}$$

$$\frac{dv}{A dt} = \frac{-\Delta P}{\frac{\alpha \mu C_s V}{A} + \mu R_m} \text{-----} 8$$

### Filtration equation for constant Pressure filtration

From equation 8

$$\begin{aligned} \frac{dv}{dt} &= \frac{-A \Delta P}{\frac{\mu \alpha C_s v + \mu R_m A}{A}} \\ &= \frac{-A^2 \Delta P}{\mu \alpha C_s v + \mu R_m} \\ \frac{dv}{dt} &= \frac{A^2 (-\Delta P)}{\mu \alpha C_s V} + \frac{A(-\Delta P)}{\mu R_m} \text{-----} 9 \end{aligned}$$

Inverting 9 (By mathematical manipulation)

$$\begin{aligned} \frac{dt}{dv} &= \frac{\mu \alpha C_s v}{A^2 (-\Delta P)} + \frac{\mu R_m}{A (-\Delta P)} \\ \frac{dt}{dv} &= K_p V + B \text{-----} 10 \end{aligned}$$

$$\text{Where } K_p = \frac{\mu \alpha C_s v}{A^2 (-\Delta P)} \quad B = \frac{\mu R_m}{A (-\Delta P)}$$

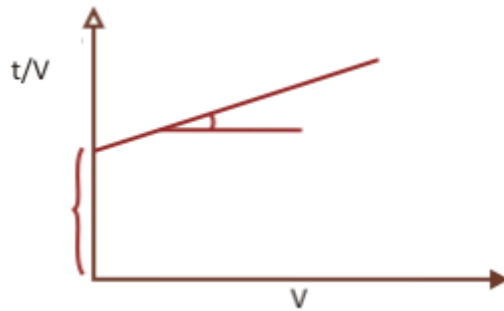

$$\int_0^t dt = \int_0^v (K_P V + B) dv$$

$$t = \frac{K_P V^2}{2} + Bv$$

$$\frac{t}{v} = \frac{K_P V}{2} + B \quad \text{--- 11}$$

From Graph Slope =  $K_p / 2$  and Intercept =  $B$

For Continuous filtration  $B = 0$

$$\text{Therefore } \Rightarrow t = \frac{K_P V^2}{2}$$

### Filtration equation for constant rate filtration

$$\frac{dv}{Adt} = \frac{-\Delta P}{\alpha \mu C_S V} + \frac{-\Delta P}{\mu R_m}$$

$$\frac{dv}{Adt} = -\Delta P \left[ \frac{1}{\alpha \mu C_S V} + \frac{1}{\mu R_m} \right]$$

$$-\Delta P = \frac{\alpha \mu C_S V}{A^2} \frac{dv}{dt} + \mu R_m \frac{dv}{Adt}$$

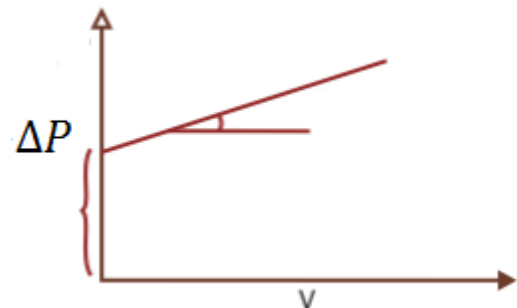

$$-\Delta P = \frac{\alpha \mu C_s}{A^2} \frac{dv}{dt} V + \mu R_m \frac{dv}{A dt}$$

$$-\Delta P = K_v V + C$$

From Graph Slope =  $K_v / 2$  and Intercept =  $C$

$$\text{Where } K_v = \frac{\alpha \mu C_s}{A^2} \frac{dv}{dt} \text{ and } C = \mu R_m \frac{dv}{A dt}$$

### Types of filtration equipments

- Plate and Frame filters
- Leaf filters
- Rotary vacuum filters
- Cross flow filtration

Rotary vacuum filters and cross flow filtration are continuous filtration equipments.

### Selection of equipments based on

- Properties of filtrate, particularly viscosity and density.
- Nature of the solid particles, particularly their size, shape and size distribution and packing characteristics.
- Solid to liquid ratio
- Need for recovery of solid or liquid.
- Need for batch or continuous operation.

### PRESSURE FILTERS

Filters which operate with super atmospheric pressure on the upstream, side of the filter medium and atmospheric or greater pressure at the downstream side of the filter medium are termed as pressure filters. In these devices, the filtering pressure is imposed by a liquid pump or by compressed gas. Hence pressure filters are fed by plunger, screw,

diaphragm or centrifugal pumps. Because of difficulty of cake discharge from a pressure environment, continuous filters are in limited use and most of the pressure filters are batch operated.

The plates and frames of the washing press are shown in the figure for ease in identification and quick proper assembling the press; it is common practice to cast buttons on the sides of plates and frames. The non – washing plate is having one button, the frame is having two buttons, and the washing plate is having three buttons. The press is assembled in such a way as to give the order of plate and frame in the form 1-2-3-2-1.... etc.

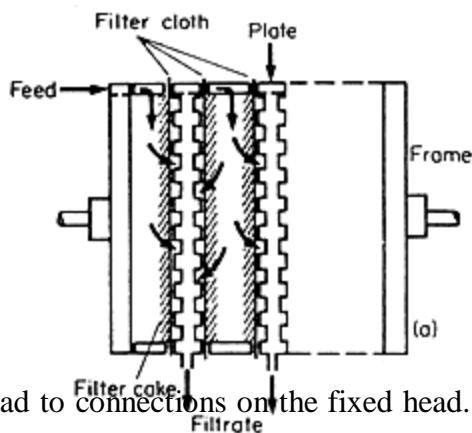

The various channels lead to connections on the fixed head. During the filtration run, a wash channel is closed by a valve on the head of the press. Filtration is carried out as in the non washing plate and frame press described earlier. When the frames are well filled (by solids retained on filter cloths), the feed channel is closed, the outlet cocks on all three button plates are closed and wash liquor is introduced into a wash channel. As the wash channel has cored openings connecting with both faces of three bottom plates. The wash liquids passes through cake, down the faces of one bottom plates , and out through the cocks on the one button plates as cocks on one button plates are open and that on three bottom plates are closed. After washing the excess liquid from cake is removed by compressed air for easy discharge of the cake.

In the press, the wash liquid passes through the whole thickness of the cake whereas the filtrate (during filtration) passes through only half the thickness of cake. The added resistance of the cake cause the liquid to distribute itself uniformly over the faces of three bottom plates and thus, to pass through the cake uniformly.

The recessed plate or chamber press is similar to the frame and plate press except that the user of frames is avoided by recessing the ribbed surface of the plates so that the

chambers are being formed in recesses between the ribbed surface of the plates so that the chambers are being formed in recesses between the successive plates. The feed is generally located in the centre of the plate. Filter cloth on the recessed surface of each side of the plate is sealed around the feed opening by two cloths sewn together at the hole or by clip nuts. The slurry containing relatively large solid particles can be readily handled in this press without fear of blocking the feed channels. When slurry is pumped in the press, it will fill all the opening between the cloths and afterwards as pumping continues the filtrate passes through the cloths runs down the ribbed surface of the plates and finally escape through outlets provided on each plate. Under pressure the cloths are forced back against the faces of the plates. This press is not adopted for washing the cake. It is hard to get a clean discharge of cake and the wear on the cloth is severe.

The plate and frame press is widely used, particularly when the cake is valuable and relatively small in quantity. It can handle slimy material.

Advantages of plate and frame press:

- Simple in construction
- Low first cost
- Very low maintenance and hence, maintenances cost is low.
- It provides large filtering area per unit for floor space occupied high operation pressures are easily obtained it is possible to alter the capacity most joints are external so leakage easily detected
- flexibility

Disadvantage of plate and frame press:

- Labor requirement is very high
- Intermittent in operation and periodic manual dismantling tend to cause high water on the cloths so filter cloth life is relatively short.
- Not suitable for high throughputs
- Presses frequently drip and leak, making housekeeping in the area a problem
- Cake washing is likely to be imperfect

### ROTARY DRUM FILTER:

The most common type of continuous vacuum filter is the rotary drum filter in which filtration, washing, partial drying and discharge of cake all take place automatically.

### CONSTRUCTION:

Fig shows the rotary drum filter. It consists essentially of a cylindrical sheet metal drum mounted horizontally. It may be from 50 to 400 cm in diameter and 50 to 800 cm long. The outer surface of the drum is formed of perforated plate. A filter medium such as canvas covers the outer surface of the drum which turns at 0.1 to 2 r/min in an agitated slurry trough. Inside the outer drum, there is a smaller drum with a solid surface. The annular space between the two drums is divided into number of compartments / sectors by radial partitions and separate connections are made between the compartments and a special type of rotary valve. As a drum rotates vacuum and air are alternately applied to each compartment.

Apart from cast iron, other materials of construction include stainless steel, titanium, plastics such as PVC, etc. these materials give much improved corrosion resistance for many slurries.

#### WORKING:

The drum is immersed to the desired depth in the slurry which is gently agitated to prevent the settling of the solids. Vacuum is applied to the portion of drum which is submerged in the slurry through the rotary valve. Because of this the liquid (filtrate) is sucked into the compartment and solids get deposited on the cloth to form a cake of desired thickness which can be regulated by adjusting the speed of the drum. With higher speeds, thinner cake will be formed and consequently, high rate of filtration will be achieved. The filtrate from the compartment then goes to a filtrate collecting tank through internal pipe and a rotary valve.

As the portion of the drum on which the cake is formed comes out of the slurry, the cake is washed by spraying wash liquid. The wash liquid leaves the filter through the rotary valve and is collected separately in a separate tank. After washing the cake enters into a drying zone as drum rotates where cake is partially dried by sucking air through the cake of solids.

After the cake of solids has been sucked as dry as possible, vacuum is cut off and cake is removed by scrapping it off with a adjustable doctors knife. A little air is blown in under the cloth to aid the removal of the cake. Once the cake is dislodged from the sector of a drum it re enters the slurry and the cycle is repeated.

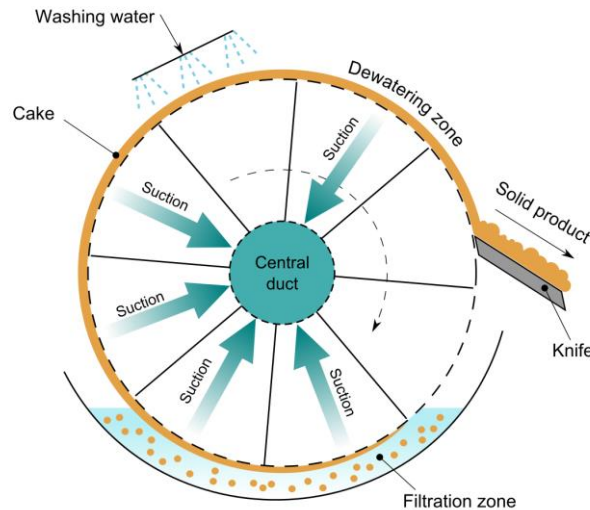

Commonly, one third of the cycle is used for filtration, one half for washing and air drying and one sixth for the removal of the cake.

Advantages of rotary drum filter:

- This filter is entirely automatic in action and thus the man power requirement is very low.  
With cake consisting of coarse solids, it is possible to remove most of the liquid from the cake before discharging.
- It has large capacity for its size , and is widely used in filtration of large quantities of free filtering material
- By altering the speed it is possible to build up cakes of varying thickness. With fine solids, the thickness of cake is small and is large with coarse solids.
- The drive may be variable speed electric motor, either direct or through v- belts. A typical operating cycle for a variable speed automatic basket centrifuge is shown in fig . Centrifuge machines are also called as hydro extractor.

### CLARIFYING FILTERS

Clarifying filters remove small amounts of solids or liquid droplets from either liquids or gases. The feed generally contains not more than 0.1 percent solids. The particles are trapped inside the filter medium or on its surface. In clarifying filters, sizes of pores in the filter medium are much larger than the particles (contrary to the case of screening) to be removed. The particles are caught by surface forces and immobilized on the surface or within the flow channels and there is reduction of effective diameter of channels, but no complete blocking.

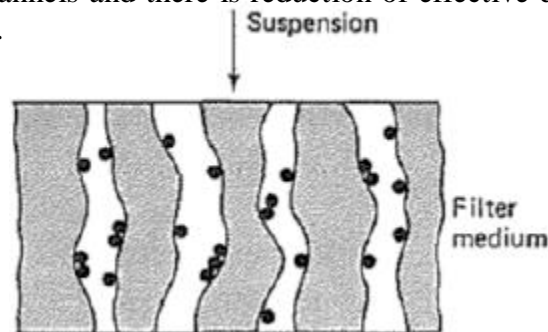

#### Principles of Clarification

If the solid particles being removed completely plug the pores of the filter medium and the rate of plugging is constant with time, the mechanism is known as **DIRECT SIEVING**.

More commonly, the particles partially block the pores, giving a gradual reduction in pore size – this is called **STANDARD BLOCKING**.

### CROSS FLOW FILTERS

Feed suspension flows under pressure at high velocity across filter medium

- Thin layer of solids may form on surface, but high velocity keeps layer from building up
- Medium is ceramic, metal, or polymer with pores small enough to exclude most of suspended particles
- Some liquid passes through as clear filtrate, leaving more concentrated suspension behind



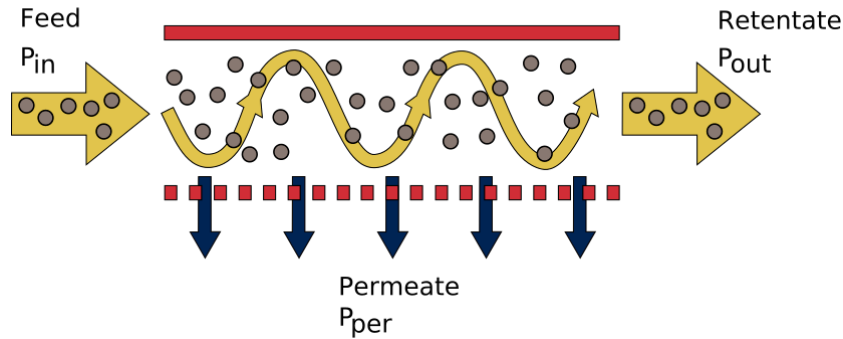

### PRINCIPLES OF CENTRIFUGATION

Particles having a size above  $5\mu\text{m}$  sediment at the bottom due to gravitation force. Such a suspension can be separated by simple filtration techniques. If the size of particles are less than  $5\mu\text{m}$  they undergo Brownian motion. In such suspension a stronger centrifugal force is applied to separate the particles.

*Principle of centrifugation*

Let us consider a body of mass  $m$  rotating in a circular path of radius  $r$  at a velocity of  $v$ . The force acting on the body in a radial direction is given by:

$$F = \frac{mv^2}{r}$$

$m$  = mass of body

$v$  = velocity of the body

$r$  = radius of circle of rotation

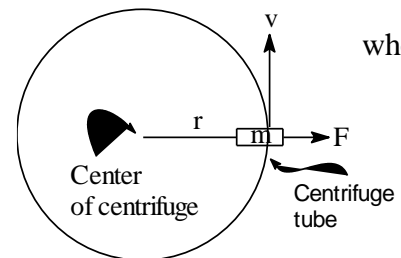

where

$F = \text{cen}$

The gravitational force acting upon the same body

$$G = mg$$

Where,

$G$  = gravitational force

$g$  = acceleration due to gravity

The centrifugal effect is the ratio of the centrifugal force and gravitational forces so that

$$C = \frac{F}{G} = \frac{mv^2}{mgr} = \frac{v^2}{gr}$$

Since,  $v = 2\pi r n$  where  $n =$  speed of rotation (r.p.m.)

$$C = \frac{F}{G} = \frac{(2\pi r n)^2}{g r} = \frac{4\pi^2 r^2 n^2}{g r} = \frac{2\pi^2}{g} D n^2 = k D n^2 \quad \text{where, } k = \frac{2\pi^2}{g} = \text{constant}$$

$D =$  maximum diameter of the centrifuge

$D$  can be measured from the center of the centrifuge to the free surface of the liquid or to the tip of the centrifuge tube.

From the equation  $C = k D n^2$  it can be concluded that

Centrifugal effect  $\propto$  diameter of centrifuge

Centrifugal effect  $\propto$  (speed of rotation)<sup>2</sup>

### Applications of this principle

1. If the particles of suspensions are very small then high centrifugal effect will be required to separate the particles. To separate such suspensions the size of the centrifuge is kept smaller but it is rotated at very high speed (rpm).
2. If a large amount of material is to be separated and a low centrifugal effect is sufficient to separate the suspension then the diameter ( $D$ ) of the centrifuge is increased and speed ( $n$ ) is kept low.

### Classification of industrial centrifuges

#### A. Perforated bowl or filter types

1. Batch type
  - (a) Top-driven
  - (b) Under-driven
2. Semicontinuous
3. Continuous

#### B. Solid-bowl or sedimentation types

1. Vertical
  - (a) Simple bowl
  - (b) Bowl with plates
2. Horizontal
  - (a) Continuous decanters

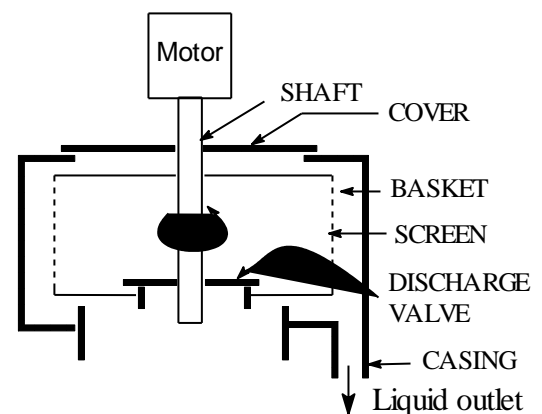

Fig. Top-driven batch centrifuge

### BATCH TYPE TOP DRIVEN CENTRIFUGE

**Construction**

It consists of a rotating basket suspended on a vertical shaft and driven by a motor from top. The sides of the basket are perforated and are also covered with a screen on the inside. Surrounding the basket is a stationary casing that collects the filtrate.

**Working**

This machine is a batch-type machine. The material (suspension) is put into the basket. Then power is applied. The basket accelerates to its maximum speed. The particles and liquid are thrown by centrifugal force to the wall of the basket. The liquid passes out through the screen and the solid particles retained on the screen as deposit. After a definite time the power is turned off, a brake applied, and the basket brought to rest. The discharge valve at the bottom of the basket is raised, and the deposited solid is cut from the side of the basket into the opening.

**Use:**

1. Crystals can be separated from mother-liquor.
2. Liquids can be clarified by removing unwanted solids dirt from oils.

**BATCH TYPE UNDER DRIVEN CENTRIFUGE****Construction**

It consists of a rotating basket placed on a vertical shaft and driven by a motor from bottom. The sides of the basket are perforated and are also covered with a screen on the inside. Surrounding the basket is a stationary casing that collects the filtrate.

**Working**

This machine is a batch-type machine. The material (suspension) is put into the basket. Then power is applied.

The basket accelerates to its maximum speed. The particles and liquid are thrown by centrifugal force to the wall of the basket. The liquid passes out through the screen and the solid particles retained on the screen as deposit. After a definite time the power is turned off, a brake applied, and the basket brought to rest. The cover at the top of the basket is raised, and the deposited solid is cut from the side of the basket and collected.

**Use:**

1. Crystals can be separated from mother-liquor.
2. Liquids can be clarified by removing unwanted solids dirt from oils.
3. In cloth industries after washing the liquid is strained and the cloths are taken out from the top cover.

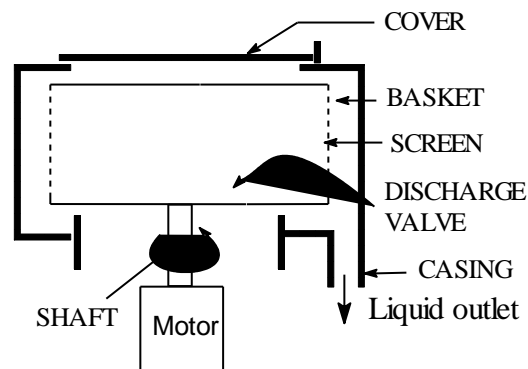

Fig. Bottom-driven batch centrifuge

## SEMI-CONTINUOUS CENTRIFUGE

**Construction**

It consists of a rotating basket placed on a horizontal shaft and driven by a motor from side. The side of the basket is perforated. Surrounding the basket is a stationary casing that collects the filtrate. Slurry is introduced through a pipe that enters the basket through the center. To wash the crystal the wash-pipe is also introduced through the center of the basket. The layer of cake is removed by a chute fitted with a knife. The knife cuts down the cake within the basket. The knife-chute assembly is raised with the help of a hydraulic apparatus.

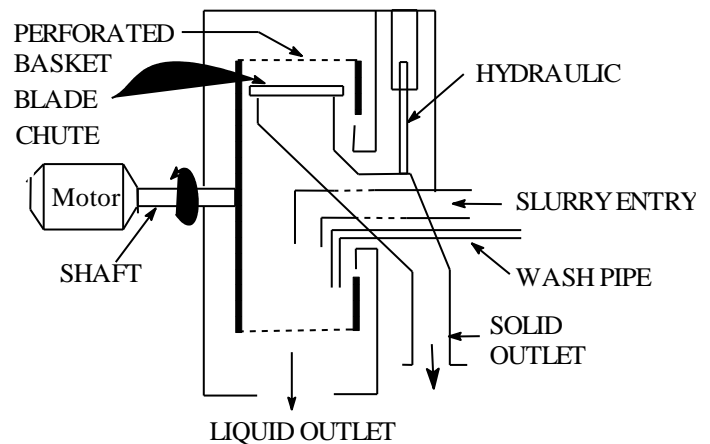

Fig. Semicontinuous centrifuge

**Working**

The basket is rotated horizontally by a motor. The slurry is introduced through the slurry entry pipe. The liquid passes out through the perforated side. The crystals remain within the basket. When the cake height is about 2-3 inches the slurry entry is stopped by a “feeler-diaphragm valve assembly”. The basket rotates a predetermined time then the cake is washed with water. The basket is rotated for another predetermined time. After that the hydraulic apparatus raise the knife-chute assembly to cut the cake. The cake is collected through the chute.

**Use**

This is a semi-continuous type of centrifuge.

1. Crystals can be separated from mother-liquor.
2. Liquids can be clarified by removing unwanted solids dirt from oils.

## CONTINUOUS HORIZONTAL CENTRIFUGE

**Construction:**

This is a sedimentation centrifuge. It consists of a cylindrical or conical *bowl* mounted horizontally and rotates at 50 to 60rpm. The bowl has a diameter of 0.5 meters. Within the bowl a *screw-conveyor* is placed that rotates in the same direction of the bowl but at a slightly slower speed than the bowl. Slurry

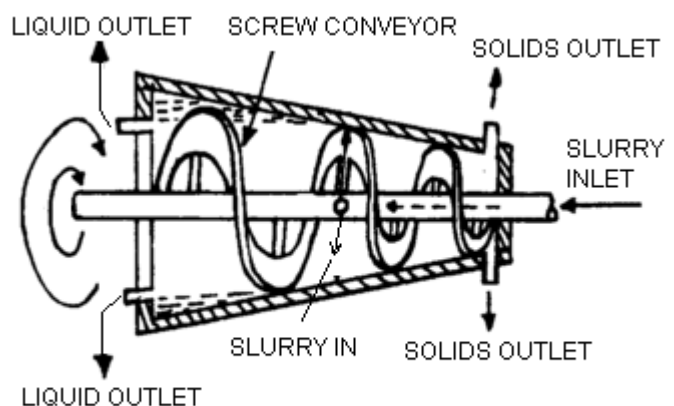

Fig. Continuous horizontal centrifuge

can enter the bowl through the shaft of the screw-conveyor.

**Working**

The bowl and the screw-conveyor both rotate in the same direction by suitable motors. The slurry is introduced through the shaft of screw conveyor. The liquid moves into the wider portion of the bowl and the solid is sedimented on the wall of the bowl. The solid cake is continuously lifted and moved to towards the narrower side of the bowl by the screw conveyor and is discharged continuously.

**Uses**

Horizontal continuous centrifuge is used when the slurry contains high proportion of solids.

**Advantages:**

1. It can filter very small particles from slurries even as small as few microns.
2. It can be used for slurries with concentrations ranging from 0.5 to 50%.

**VERTICAL SOLID BOWL CENTRIFUGE (SUPER CENTRIFUGE)****Principle:**

It is a solid bowl type continuous centrifuge used for separating two immiscible liquid phases. It is a sedimentation type centrifuge. During centrifugation the heavier liquid is thrown against the wall of the bowl while the lighter liquid remains as an inner layer. The two layers are simultaneously separated.

**Construction:**

It consists of a long, hollow, cylindrical bowl of small diameter. The bowl is suspended from a flexible spindle at the top and the bottom is fitted loosely in a bush. It is rotated on its vertical axis. Feed is introduced through the bottom through a nozzle. Two liquid outlets are provided at different heights. Inside the bowl there are three baffles (not shown in the figure) to catch the liquid and force it to travel at the same speed of rotation as the bowl wall.

**Working:**

The centrifuge is allowed to rotate on its vertical axis at about 2000rpm. The feed is introduced at the bottom through a nozzle under pressure. During centrifugation, two liquid phases separated based on their densities. The heavier liquid

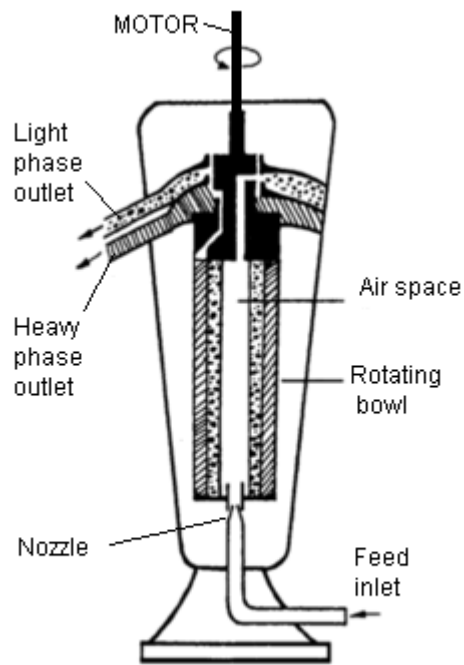

Fig. Supercentrifuge

moves towards periphery and the lighter liquid forms an inner layer. Both liquid climbs to the top of the vertical bowl. These two layers are simultaneously separately removed from different heights through modified outlets.

**Uses:**

Supercentrifuge is used for separating liquid phases of emulsions in foods and pharmaceuticals.

### CONICAL DISK CENTRIFUGE (DE LAVAL CLARIFIER)

**Principle:**

It is a sedimentation centrifuge. The separation is based on the difference in the densities between the phases under the influence of centrifugal force.

**Construction:**

It consists of a shallow form of bowl containing a series of conical discs attached to the central shaft at different heights. The discs are made up of a thin sheet of metal or plastic separated by narrow spaces. Holes are there on the conical discs half-way in between the axis and the wall of the bowl so that the holes form channels through which the liquid passes.

**Working:**

The centrifuge is rotated at low speed. The feed is introduced through the concentric tube surrounding the shaft. The feed flows down and enters into the spaces between the discs. During centrifugation, the liquid flows into the channels (through the holes at the center of the discs) and upwards. The heavy liquids moves towards periphery of the bowl and the lighter liquids towards the center. The solids, if any, are deposited at the bottom of the conical bowl, which is removed from time to time. The heavier and lighter liquids are taken out of the bowl through separate outlets.

**Uses:**

1. Two immiscible liquid phases are separated out after a liquid / liquid extraction.
2. Suspensions containing low concentration of solids can be separated quickly.
3. Gelatinous solids can be separated by disc-cone centrifuge. Such materials are difficult to filter because they clog the filter medium.
4. In the manufacture of insulin, the liquor is clarified to remove the precipitated proteins.
5. Separation of cream from milk, concentration of rubber latex, removing solids from lubricating oils, inks and beverages are possible.

**Advantages:**

1. They are compact and occupy very small space.
2. It has very high separating efficiency.

**Disadvantages:**

1. Construction is complicated and difficult to wash also.
2. Its capacity is limited.
3. It is not suitable for cake forming solids.

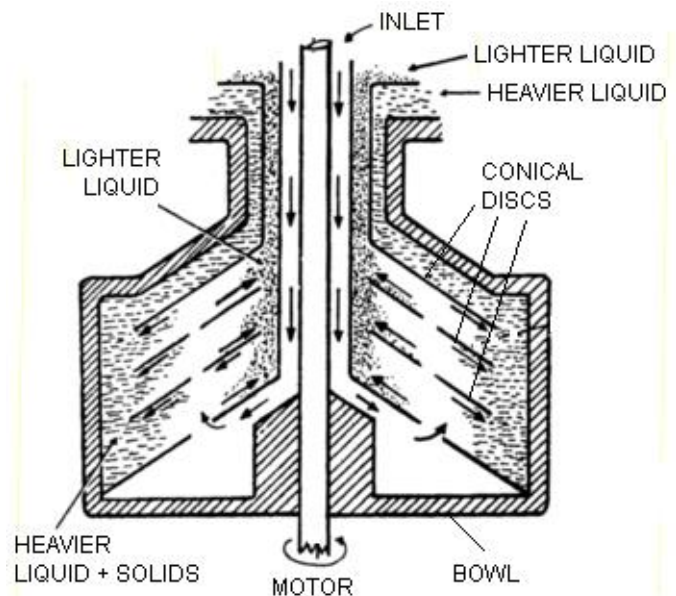

Fig. Conical disk centrifuge

Unit – VMIXING AND AGITATION

**Agitation** is a means whereby mixing of phases can be accomplished and by which mass and heat transfer can be enhanced between phases or with external surfaces.

**Mixing** is concerned with all combinations of phases of which the most frequently occurring ones are

- Gases with gases
- Gases into liquids: dispersion.
- Gases with granular solids: fluidization, pneumatic conveying; drying.
- Liquids into gases: spraying.
- Liquids with liquids: dissolution, emulsification, dispersion
- Liquids with granular solids: suspension.
- Pastes with each other and with solids.
- Solids with solids: mixing of powders.

**Purpose of Agitation**

- Suspending solid particles in a liquid
- Blending miscible liquids e.g. methanol-water
- Dispersing a gas through a liquid in the form of small bubbles
- Dispersing a second liquid, immiscible with first to form an emulsion or suspension of fine drops
- Promoting heat transfer between liquid and a coil or jacket.

**Agitated Vessels**



Figure shows stirred tank design, not to scale, showing a lower radial impeller and an upper axial impeller housed in a draft tube. Four equally spaced baffles are standard.  $H$  = height of liquid level,  $D$  = tank diameter,  $d$  = impeller diameter.

- Round bottom to eliminate corners where fluid cannot penetrate.
- Impeller is mounted on a shaft.
- Shaft driven by a motor.
- Baffles to reduce tangential motion of fluid.

### Types of Impellers

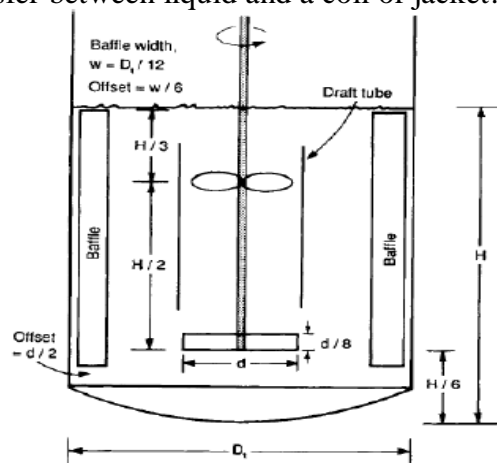
A rotating impeller in a fluid imparts flow and shear to it, the shear resulting from the flow of one portion of the fluid past another. Flow is in the axial or radial directions so that impellers are classified conveniently according to which of these flows is dominant.

A few common types are illustrated in figure and are described as follows:

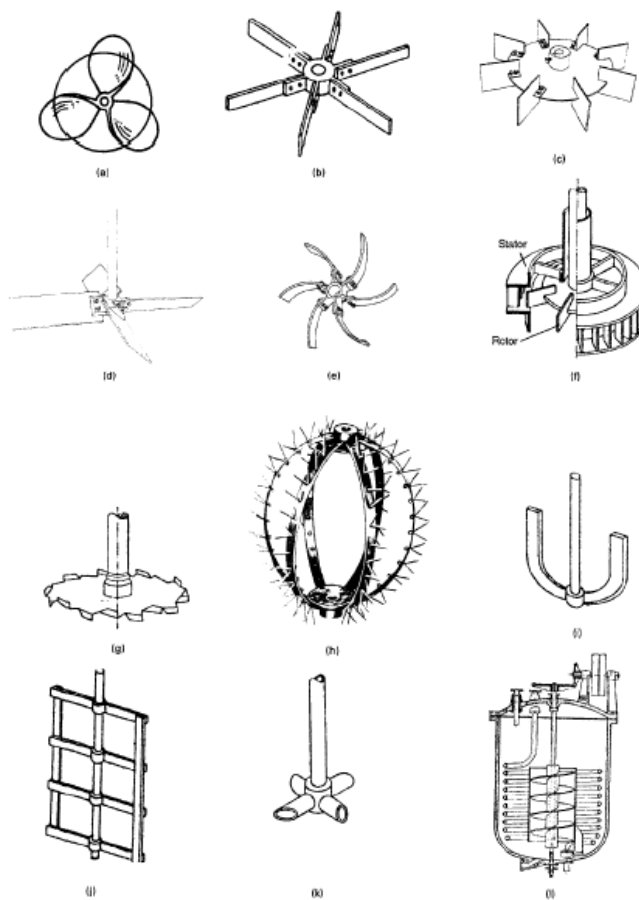

- a. The three-bladed mixing propeller is modeled on the marine propeller but has a pitch selected for maximum turbulence. They are used at relatively high speeds (up to 1800rpm) with low viscosity fluids, up to about 4000cP. Many versions are available: with cutout or perforated blades for shredding and breaking up lumps, with saw tooth edges as in Figure (g) for cutting and tearing action and with other than three blades. The stabilizing ring shown in the illustration sometimes is included to minimize shaft flutter and vibration particularly at low liquid levels.
- b. The turbine with flat vertical blades extending to the shaft is suited to the vast majority of mixing duties up to 100,000CP or so at high pumping capacity. The simple geometry of this design and of the turbines of Figures (c) and (d) has inspired extensive testing so that prediction of their performance is on a more rational basis than that of any other kind of impeller.
- c. The horizontal plate to which the impeller blades of this turbine are attached has a stabilizing effect. Backward curved blades may be used for the same reason as for type (e).
- d. Turbine with blades is inclined  $45^\circ$  (usually). Constructions with two to eight blades are used, six being most common. Combined axial and radial flows are achieved. Especially effective for heat exchange with vessel walls or internal coils.
- e. Curved blade turbines effectively disperse fibrous materials without fouling. The swept back blades have a lower starting torque than straight ones, which is important when starting up settled slurries.
- f. Shrouded turbines consisting of a rotor and a stator ensure a high degree of radial flow and shearing action, and are well adapted to emulsification and dispersion.
- g. Flat plate impellers with saw tooth edges are suited to emulsification and dispersion. Since the shearing action is localized, baffles are not required. Propellers and turbines also are sometimes provided with saw tooth edges to improve shear.
- h. Cage beaters impart a cutting and beating action. Usually they are mounted on the same shaft with a standard propeller. More violent action may be obtained with spinned blades.
- i. Anchor paddles fit the contour of the container, prevent sticking of pasty materials, and promote good heat transfer with the wall.
- j. Gate paddles are used in wide, shallow tanks and for materials of high viscosity when low shear is adequate. Shaft speeds are low. Some designs include hinged scrapers to clean the sides and bottom of the tank.

### Flow patterns in Agitated Vessels

Depends upon

- Type of impeller
- Characteristics of the liquid (viscosity)
- Size and proportions of the tank, baffles and the impeller

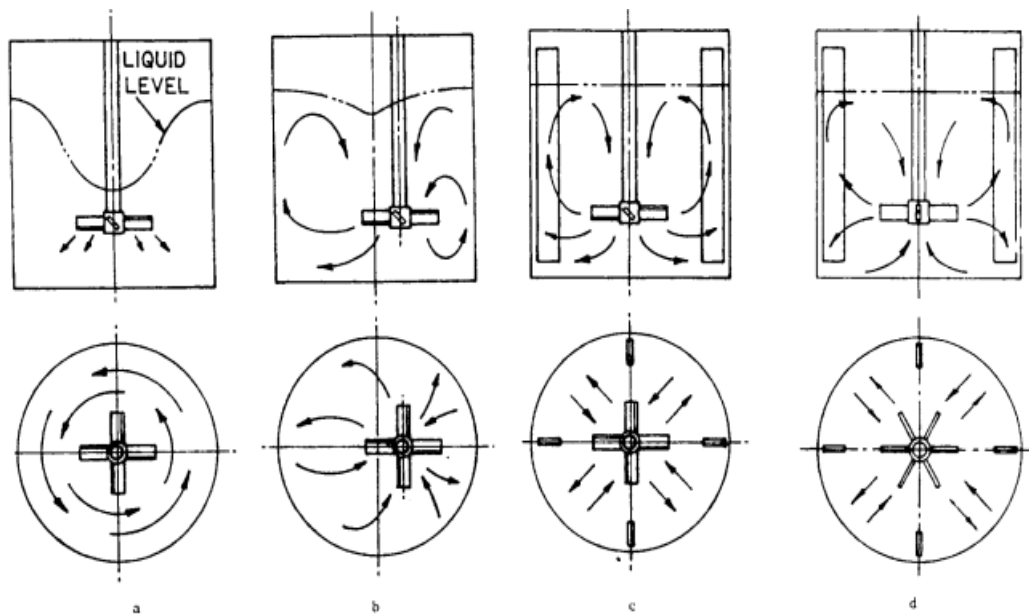

**Figure** Agitator flow patterns. (a) Axial or radial impellers without baffles produce vortices. (b) Offcenter location reduces the vortex. (c) Axial impeller with baffles. (d) Radial impeller with baffles.

- In unbaffled tank there are strong tangential flows and vortex formation at moderate stirrer speeds
- With baffles, vertical flows are increased and rapid mixing of liquid.
- Two or more impellers can be mounted on single shaft for a long vertical cylindrical tank
- Lowest impeller is usually a radial flow impeller (straight blade turbine); the upper is axial flow
- Lowest impeller is about one impeller diameter above the bottom of the tank.

#### **Paddle type agitator**

- Speed range 5-300rpm.
- Used for large size vessels.

- Agitator size almost touching vessel wall.
- Normally used for reaction vessel having jacket by providing good heat transfer area.
- Doesn't allow solid buildup at the wall.

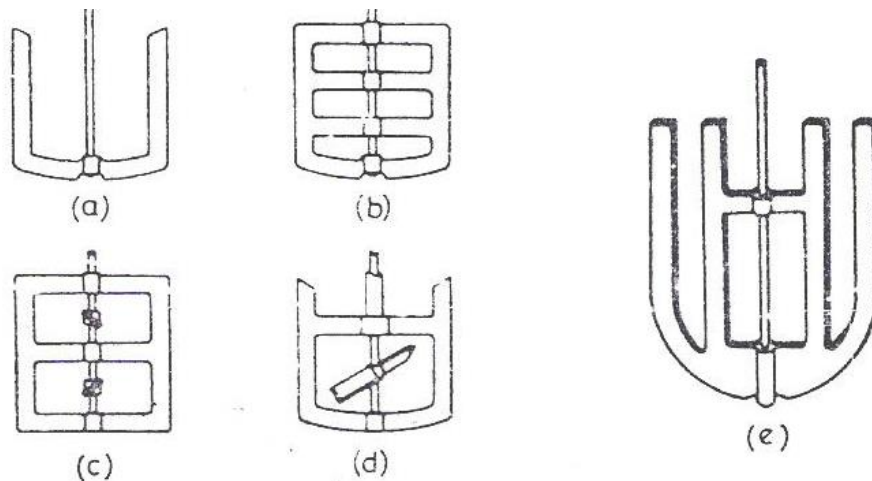

**Fig. Paddle Agitators: (a) Anchor, (b) Gate, (c) Gate with pitched cross arms, (d) Anchor with pitched cross arms, (e) Combined anchor and gate**

### **Propeller type agitator**

#### **Axial flow impellers**

- Maximum flow is achieved at axis of agitator
- Maximum vessel size is 1m<sup>3</sup>
- Maximum speed is 415 r/minute
- Diameter of propeller is 15-30% of vessel diameter

#### **Turbine type agitator**

- Motion is achieved due to rotary action of impeller
- Two types are available
  - Axial flow turbine
  - Radial flow turbine
- flat bladed
- pitched bladed
- curved bladed

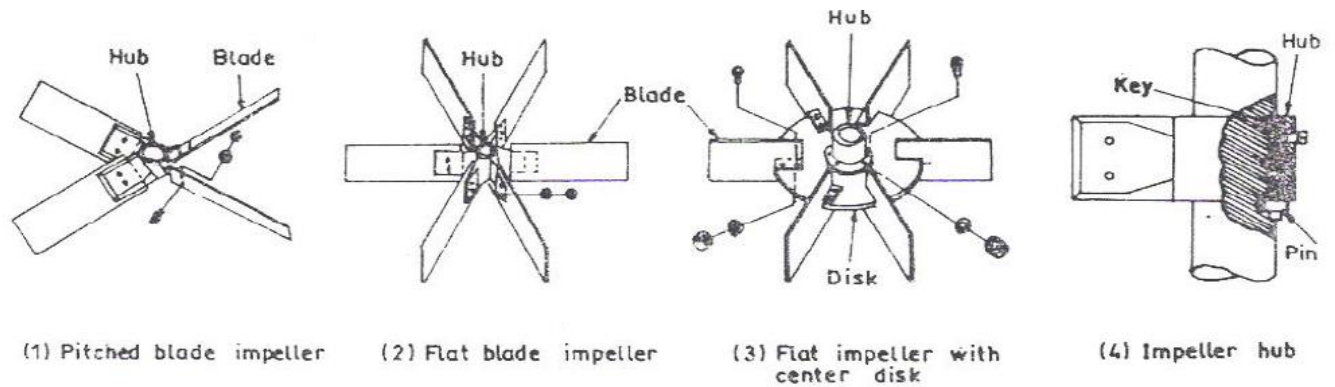
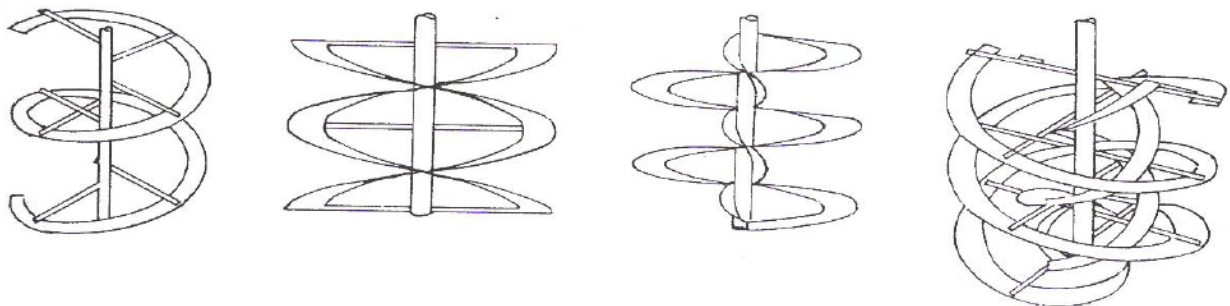

*Fig. Types of turbine impeller*

### Helical or ribbon type agitator

Four types are available in market

- Single helical
- Double helical
- Helical screw
- Ribbon type
- Good for top to bottom liquid circulation
- Used for blending for pseudo plastic materials
- High power requirement



*Fig. Types of helical ribbon agitator*

## MIXING OF POWDERS AND PASTES

Industries such as foods, cosmetics, pharmaceuticals, plastics, rubbers, and also some others have to do with mixing of high viscosity liquids or pastes, of powders together and of powders with pastes. Much of this kind of work is in batch mode. The processes are so diverse and the criteria for uniformity of the final product are so imprecise that the non-specialist can do little in the way of equipment design, or in checking on the recommendations of equipment manufacturers.

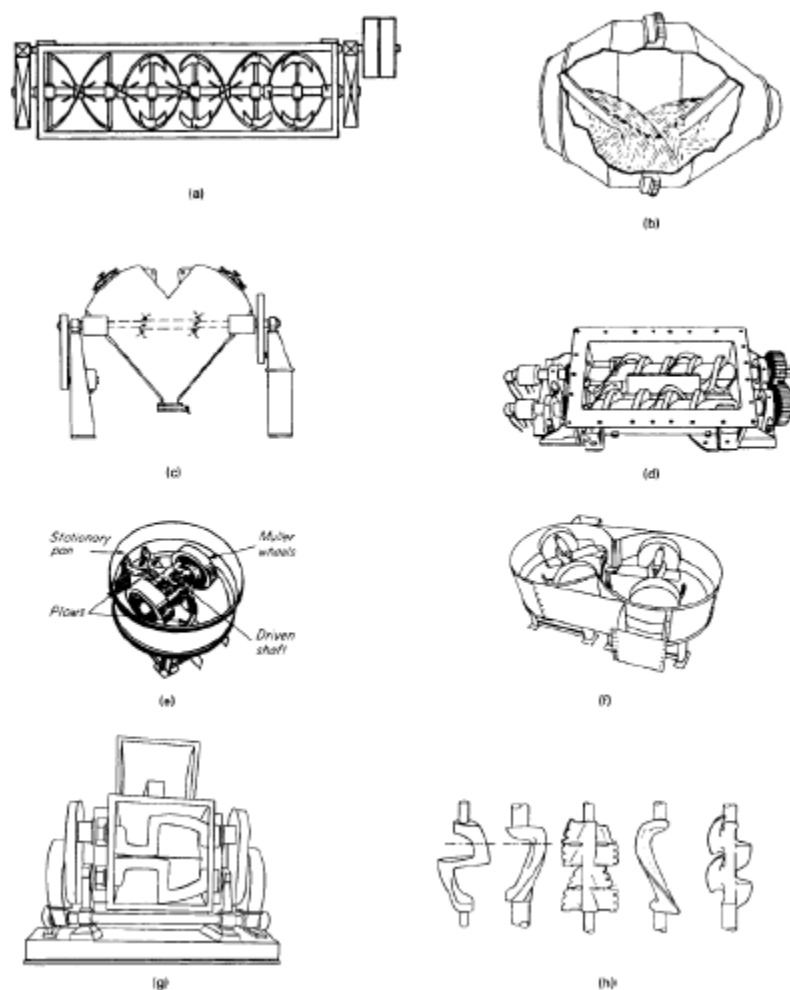

Figure. Some mixers and blenders for powders and pastes. (a) Ribbon blender for powders. (b) Flow pattern in a double cone blender rotating on a horizontal axis. (c) Twin shell (Vee-type); agglomerate breaking and liquid injection are shown on the broken line. (d) Twin rotor; available with jacket and hollow screws for heat transfer. (e) Batch Muller. (f) Twin mullers operated continuously. (g) Double-arm mixer and kneader. (h) Some types of blades for the double-arm kneader.

## POWER REQUIREMENT

For an effective mixing, the volume of fluid circulated in a vessel via an impeller must be sufficient to sweep out the entire vessel in a reasonable time.

### FACTORS AFFECTING THE POWER REQUIREMENT:

- Properties of fluid to be agitated
- Height of the liquid
- Tank size and dimensions
- Agitator type and size
- Speed of agitator

## Terminology in Power Calculation

### (i) Flow Number

$$q \propto n D_a^3 \quad N_Q = \frac{q}{n D_a^3}$$

Where  $q$  is the volumetric flow rate, measured at the tip of the blades,  $n$  is the rotational speed (rpm),  $D_a$  is the impeller diameter.

$N_Q$  is constant for each type of impeller. For flat-blade turbine (FBT), in a baffled vessel,  $N_Q$  may be taken as 1.3; For marine propellers (Square pitch),  $N_Q = 0.5$ ; For four blade 45° turbine,  $N_Q = 0.87$ ;

### (ii) The Reynolds number, $N_{Re}$

$$N_{Re} = \frac{D_a^2 n \rho}{\mu}$$

### (iii) The Froude number, $N_{Fr}$

$$N_{Fr} = \frac{n^2 D_a}{g}$$

Froude No. is a measure of the ratio of the inertial stress to the gravitational force per unit area acting on the fluid. It appears in the dynamic situations where there is significant wave motion on a liquid surface.

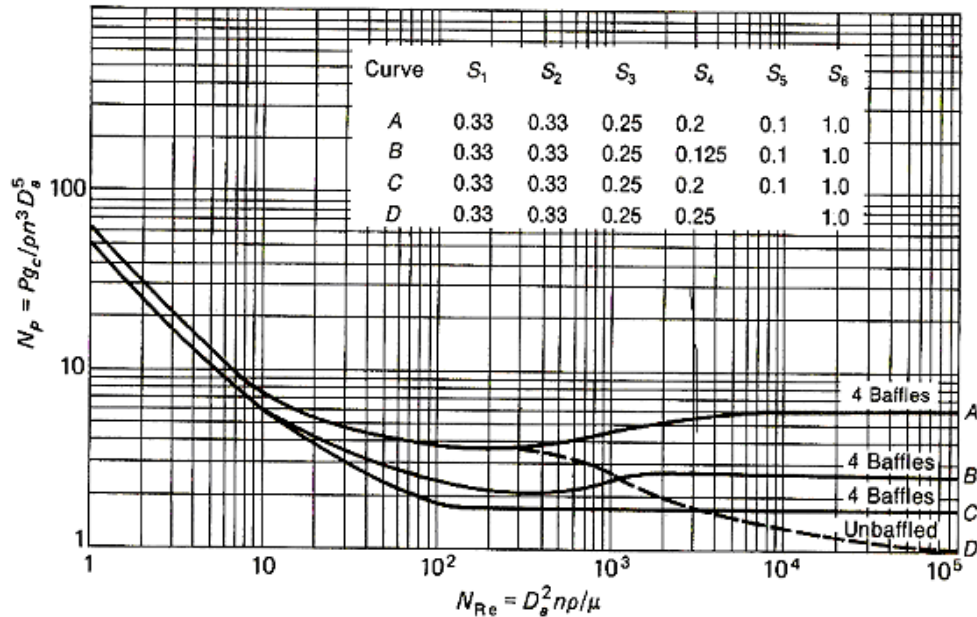

Power number  $N_p$  versus  $N_{Re}$  for six-blade turbines. With the dashed portion of curve D, the value of  $N_p$  read from the figure must be multiplied by  $N_{Fr}^m$ .

Flow number ( $N_Q$ )

Let  $u_2$  be the blade velocity  $V_{u_2}'$  and  $V_{r_2}'$  tangent and radial velocity  $V_2'$  is the total liquid velocity of blade

$$\text{Assume } V_{u_2}' = K u_2 \quad \text{_____ 1}$$

We know that

$$U_2 = \pi D_a n \quad \text{_____ 2}$$

Where  $n$  = Impeller speed

Substitute 2 in 1



$$Vu_2' = K \pi D_a n \quad \text{_____} \quad 3$$

$$q = Vr_2' \times A_p \quad \text{_____} \quad 4$$

where  $A_p$  = Area of cylinder

$$A_p = \pi D_a W$$

From diagram

$$Vr_2' = (u_2 - Vu_2') \tan \beta_2' \quad \text{_____} \quad 5$$

$$= (\pi D_a n - K \pi D_a n) \tan \beta_2'$$

$$Vr_2' = \pi D_a n (1-K) \tan \beta_2' \quad \text{_____} \quad 6$$

Substitute 6 in 5

$$q = \pi D_a n (1-K) \tan \beta_2' \times \pi D_a W$$

$$q = \pi^2 D_a^2 n (1-K) \tan \beta_2' W \quad \text{_____} \quad 7$$

for, similar geometry impellers  $Da = W$

$$q = \pi^2 D_a^3 n (1-K) \tan \beta_2'$$

Given some values of  $K$  and  $\beta_2'$

$$\frac{q}{n D_a^3} = N_Q$$

$N_Q$  = flow number, Ability of impeller to discharge the liquid inside the vessel

Power number ( $N_p$ )

Power required for the tank can be calculated as volume produced by impeller and kinetic energy per unit volume/m<sup>3</sup>

$$N_p = qE_k$$

$$q = N_Q n D_a^3$$

$$E_k = \frac{\rho V_2'^2}{2g_c}$$

$V_2'$  – small than  $u_2$

$$\frac{V_2'}{u_2} = \alpha$$

$$E_k = \frac{\rho \alpha V_2'^2}{2g_c} = \frac{\rho \alpha^2 \pi^2 n^2 D_a^2}{2g_c}$$

Substitute all equation in  $N_p$

$$P = \frac{D_a^2 N_Q n \rho \alpha^2 \pi^2 n^2 D_a^2}{2g_c}$$

$$= \frac{n^3 D_a^5 \rho}{g_c} \left( \frac{\alpha^2 \pi^2 N_Q}{2} \right)$$

$$\frac{P g_c}{n^3 D_a^5 \rho} = N_p = \frac{\alpha^2 \pi^2 N_Q}{2}$$

Power number is function of Reynolds number and flow number

$$P = f(D_a, n, \rho, g, \mu)$$

$$D_a - m = L$$

$$\rho - \text{kg/m}^3 = \text{ML}^{-3}$$

$$\mu - \text{kg/m-s} = \text{ML}^{-1}\text{T}^{-1}$$

$$n - \text{rpm} = \text{T}^{-1}$$

$$P - \text{W.J/s} = \text{kgm}^2/\text{s}^3 = \text{ML}^{-2}\text{T}^{-3}$$

$$g - \text{m/s}^2 = \text{LT}^{-2}$$

we know that,

$$\varphi(D_a, n, \rho, g, \mu) = 0$$

Number of variables = 6

Number of fundamental quantities = 3

Total number of  $\pi$ -terms = 6-3

$$\pi_1 = (D_a^a \rho^b n^c) P \quad \underline{\hspace{2cm}} \quad 1$$

$$\pi_2 = (D_a^a \rho^b n^c) \mu \quad \underline{\hspace{2cm}} \quad 2$$

$$\pi_3 = (D_a^a \rho^b n^c) g \quad \underline{\hspace{2cm}} \quad 3$$

From 1

$$\text{M}^0 \text{L}^0 \text{T}^0 = \text{L}^a (\text{ML}^{-3})^b (\text{T}^{-1})^c (\text{ML}^2 \text{T}^{-3})$$

Equation 'M' terms

$$0 = b + 0 \Rightarrow b = -1$$

'L' terms

$$0 = a - 3b + 2$$

'T' terms

$$0 = -c - 3$$

$$c = -3$$

Substitute the value in 'L'

$$a = -5$$

$$\pi_1 = D^{-5} \rho^{-1} n^{-3} P$$

$$\pi_1 = \frac{P}{D^5 n^3 \rho}$$

Similarly  $\pi_2 = (D_a^a \rho^b n^c) \mu$

$$M^0 L^0 T^0 = L^a (ML^{-3})^b (T^{-1})^c (ML^{-1} T^{-1})$$

'M' terms  $0 = b + 1 ; b = -1$

'L' terms  $0 = a - 3b - 1 ; a = -2$

'T' terms  $0 = -c - 1 ; c = -1$

Substituting the values in above equation

$$\pi_2 = (D_a^{-2} \rho^{-1} n^{-1}) \mu$$

$$\pi_2 = \frac{\mu}{\rho n D_a^2}$$

$$\pi_3 = (D_a^a \rho^b n^c) g$$

$$M^0 L^0 T^0 = L^a (ML^{-3})^b (T^{-1})^c (L T^{-2})$$

'M' terms  $b=0$

'L' terms  $0 = a - 3b + 1$  ;  $a = -1$

'T' terms  $0 = -c - 2$  ;  $c = -2$

$$\pi_3 = (D_a^{-1} \rho^0 n^{-2}) g$$

$$\pi_3 = \frac{g}{D_a n^2}$$

$$\varphi(\pi_1, \pi_2, \pi_3) = 0$$

$$\varphi\left(\frac{P}{D^5 n^3 \rho}, \frac{\mu}{\rho n D_a^2}, \frac{g}{D_a n^2}\right) = 0$$

$$\frac{P}{D^5 n^3 \rho} = \varphi\left(\frac{\rho n D_a^2}{\mu}, \frac{D_a n^2}{g}\right)$$

$$\text{Power No} = \varphi(N_{Re}, N_{Fr})$$

## Power Consumption in Non-Newtonian Liquids

Newtonian fluid:

$$\tau_{xy} = \mu \frac{dv_x}{dy} = \mu \dot{\gamma} \quad : \quad \dot{\gamma} = \frac{dv_x}{dy}$$

Power Law Fluid:

$$\tau_{xy} = K \dot{\gamma}^n \quad : \quad \mu_a = \frac{\tau_{xy}}{\dot{\gamma}} = K \dot{\gamma}^{n-1}$$

When  $n < 1$ , viscosity decreases with shear

When  $n > 1$ , viscosity increases with shear

- Non-Newtonian liquids – viscosity varies with shear rate
- Use apparent viscosity,  $\mu_a$

$$N_{Re,n} = \frac{n D_a^2 \rho}{\mu_a}$$

$$\mu_a = K \left( \frac{du}{dy} \right)_{av}^{n-1}$$

- For a straight-blade turbine in pseudoplastic liquids

$$\left( \frac{du}{dy} \right)_{av} = 11n$$